

BAUX

ACOUSTIC WOOD WOOL

BAUX IS FOUNDED
ON THE BELIEF
THAT BUILDING
MATERIALS
SHOULD BE BOTH
SURPRISINGLY
FUNCTIONAL AND
REMARKABLY
BEAUTIFUL.

LET'S BUILD!

BAUX ACOUSTIC TILES



ACOUSTIC TILES SQUARE

25 mm thick
2.97 tiles per m²

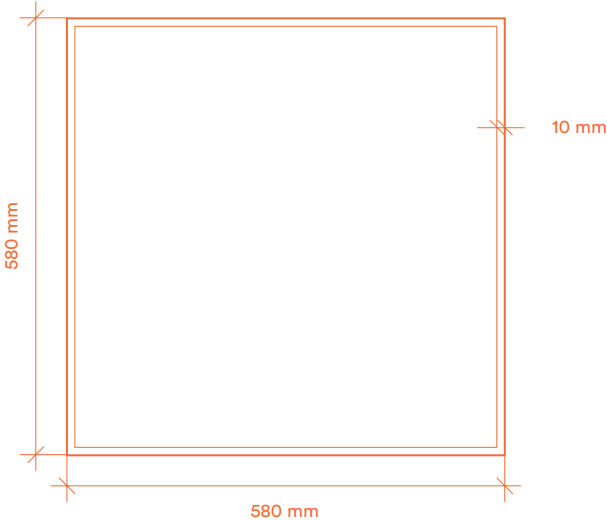

25 mm thick
11.9 tiles per m²

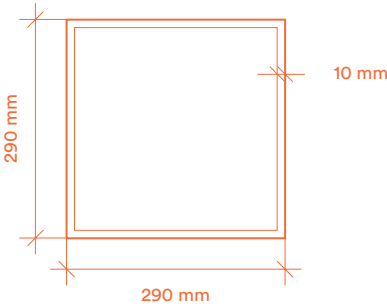

BAUX



ACOUSTIC TILES RECTANGLE

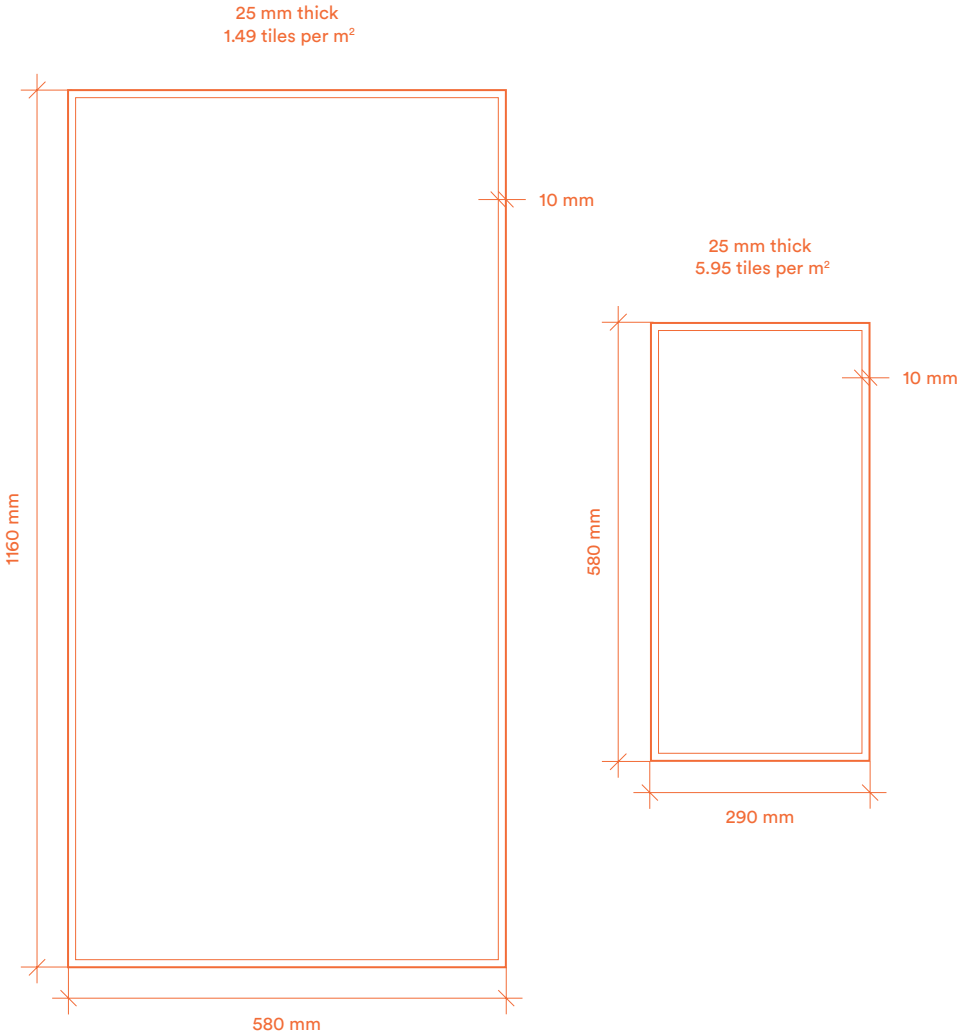

BAUX

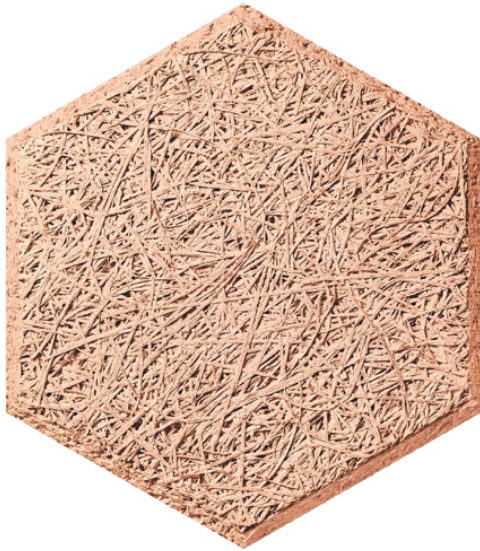

ACOUSTIC TILES HEXAGON

25 mm thick
4.45 tiles per m²

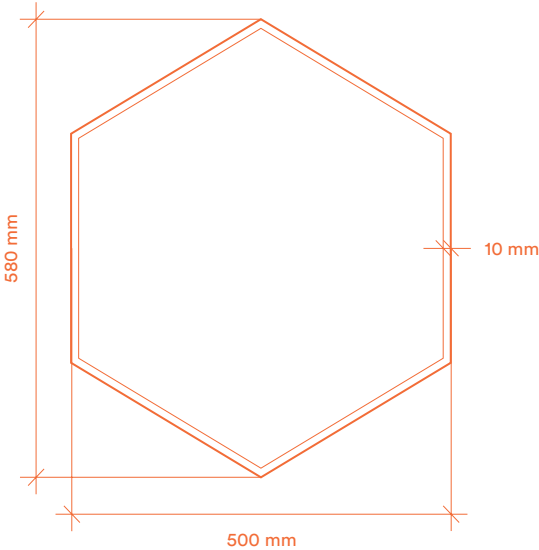

25 mm thick
17.8 tiles per m²

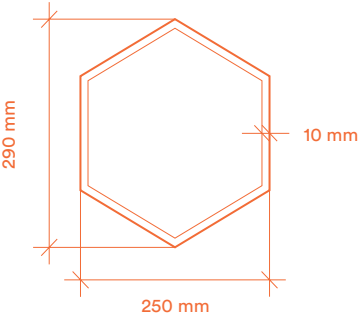

BAUX



ACOUSTIC TILES CIRCLE

25 mm thick
3.78 tiles per m²

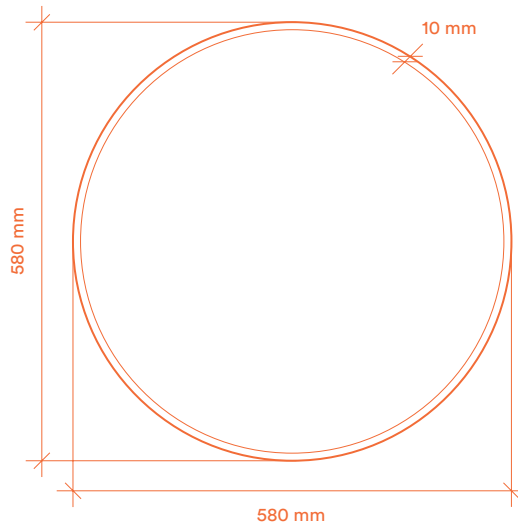

25 mm thick
15.1 tiles per m²

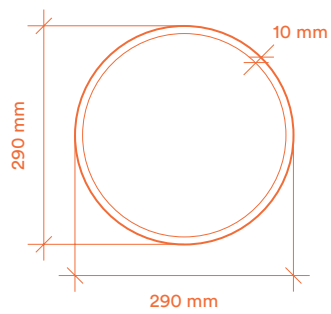

BAUX

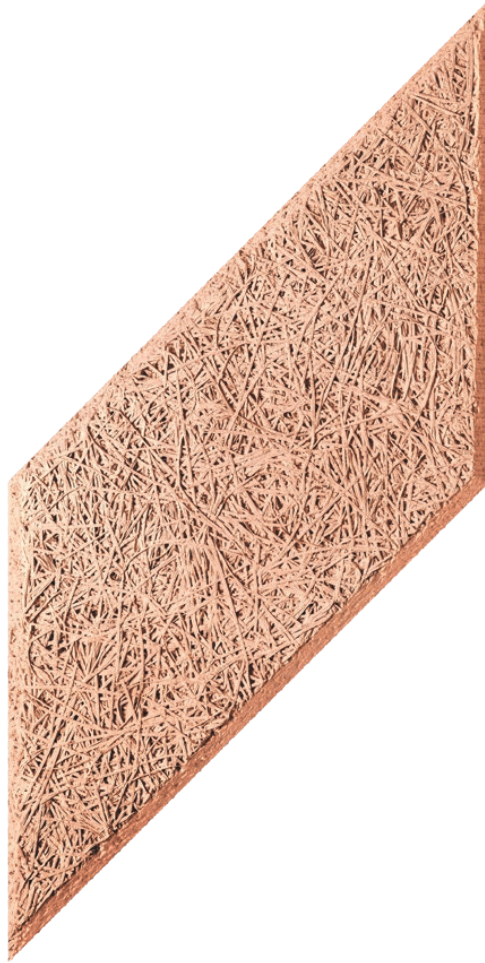

ACOUSTIC TILES PARALLELOGRAM

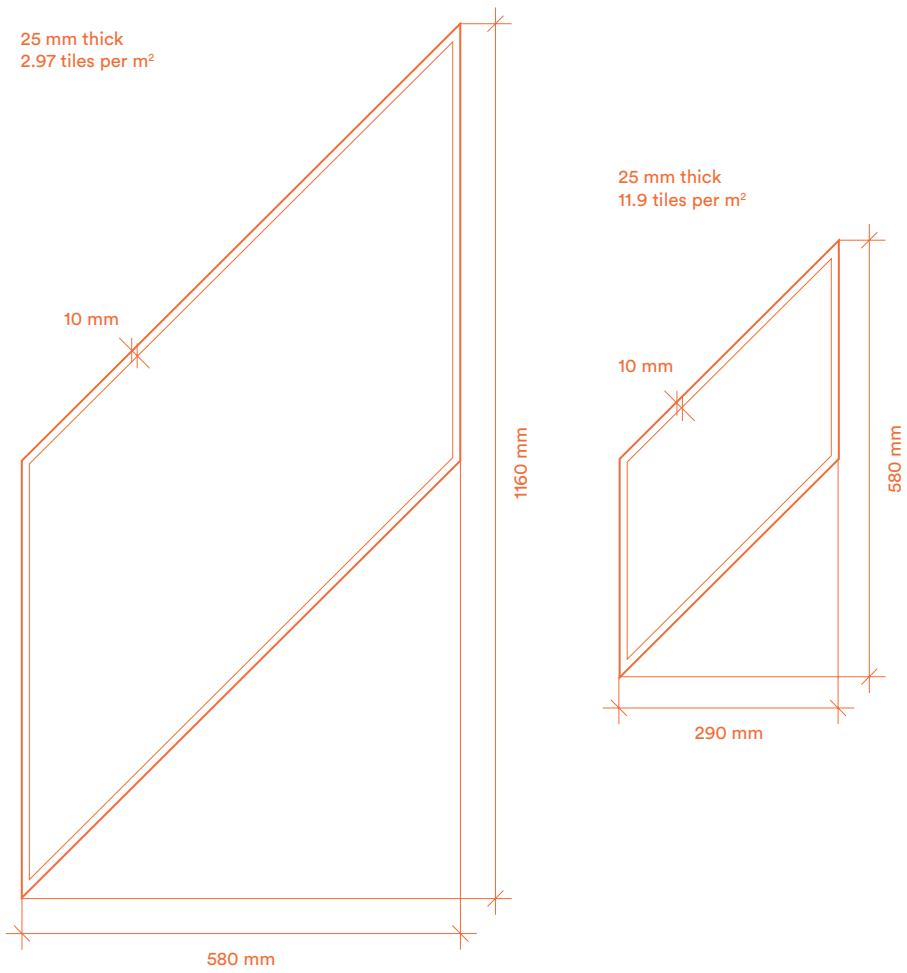

BAUX

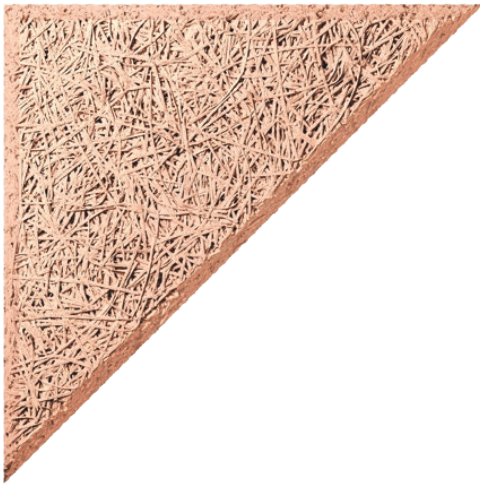

ACOUSTIC TILES TRIANGLE

25 mm thick
5.95 tiles per m²

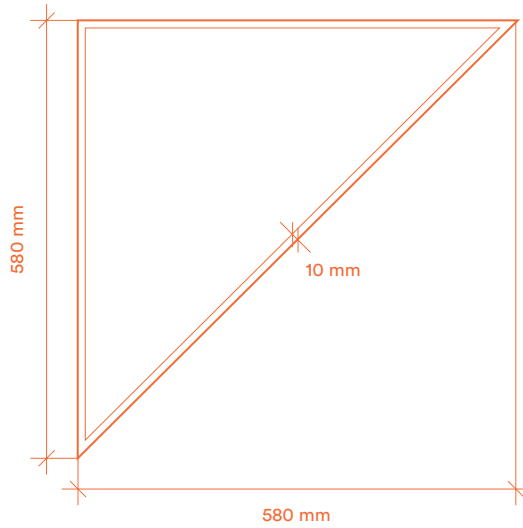

25 mm thick
23.8 tiles per m²

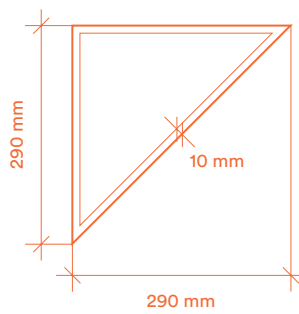

BAUX



ACOUSTIC TILES
PLANK
NATURALLY COLOURED

25 mm thick
2.97 tiles per m²

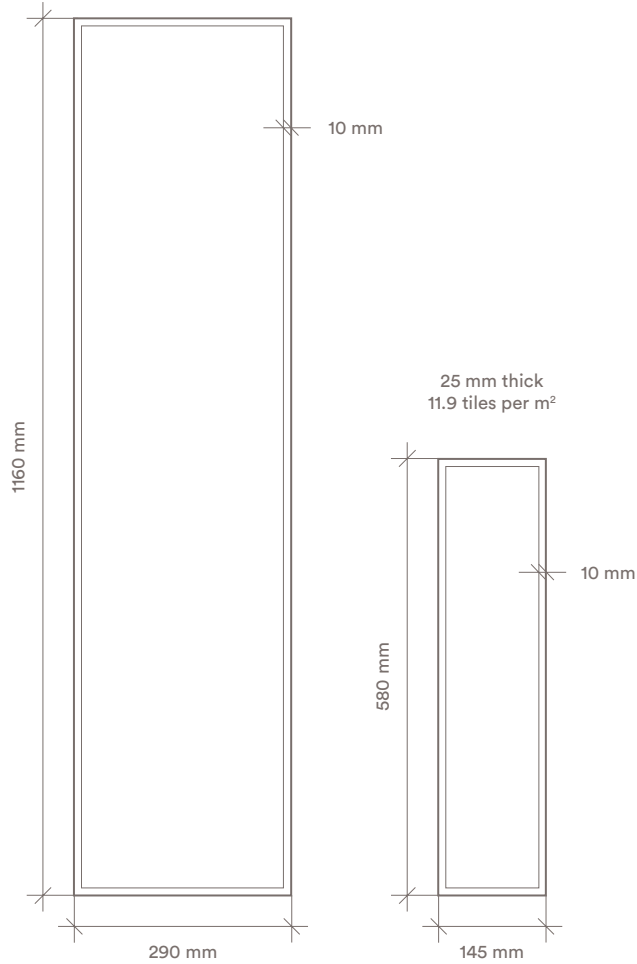

BAUX



ACOUSTIC TILES IN USE
SQUARE, RECTANGLE
PARALLELOGRAM, TRIANGLE

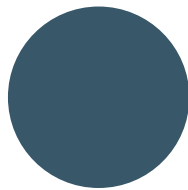

NCS S 6020-B

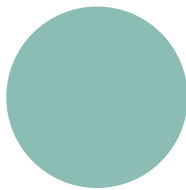

NCS S 2020-B70G

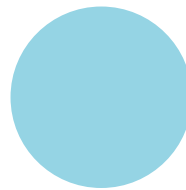

NCS S 0530-B10G

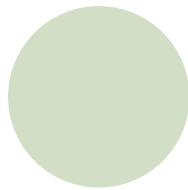

NCS S 1010-G30Y

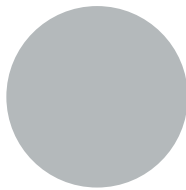

NCS S 2502-B

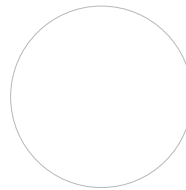

NCS S 0300-N

BAUX



ACOUSTIC TILES IN USE
PARALLELOGRAM, TRIANGLE

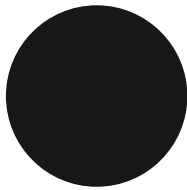

NCS 9000-N

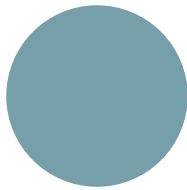

NCS S 3020-B10G

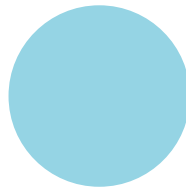

NCS S 0530-B10G

BAUX



ACOUSTIC TILES IN USE TRIANGLE

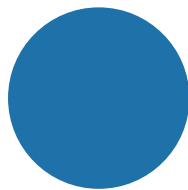

NCS S 3050-R90B

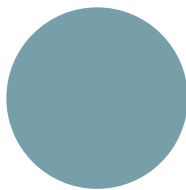

NCS S 3020-B10G

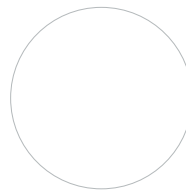

NCS S 0300-N

BAUX



ACOUSTIC TILES IN USE HEXAGON

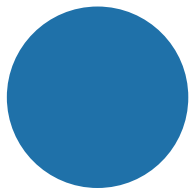

NCS S 3050-R90B

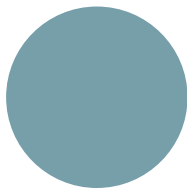

NCS S 3020-B10G

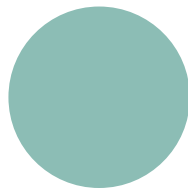

NCS S 2020-B70G

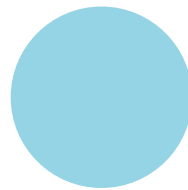

NCS S 0530-B10G

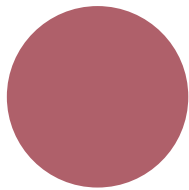

NCS 3040-R10B

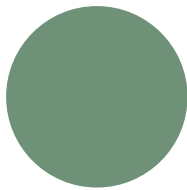

NCS S 4020-G10Y

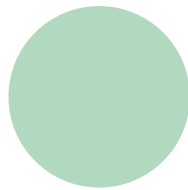

NCS S 1020-G

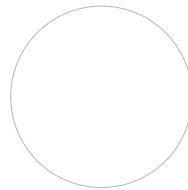

NCS S 0300-N

BAUX

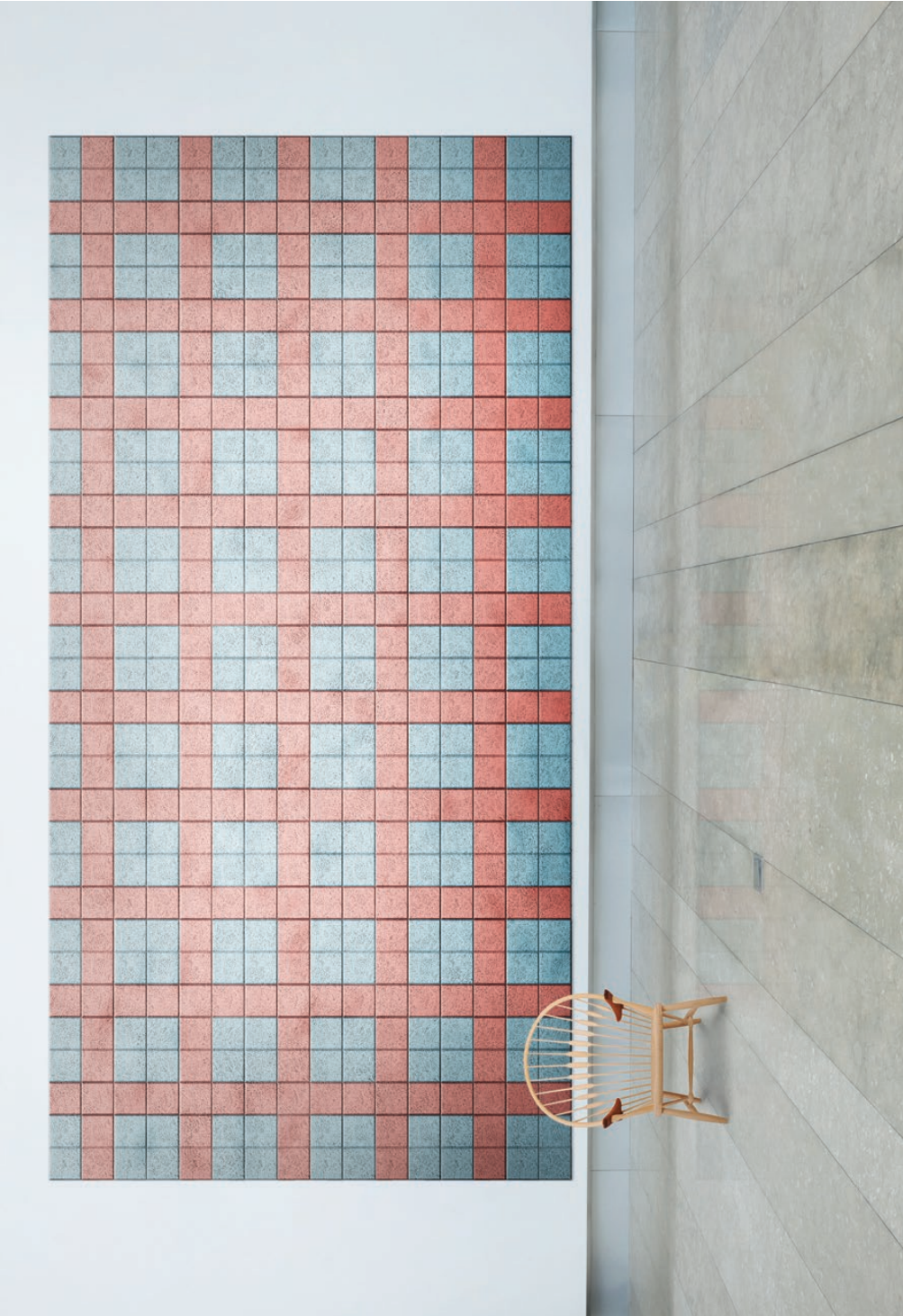

ACOUSTIC TILES IN USE SQUARE

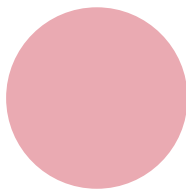

NCS S 1030-R10B

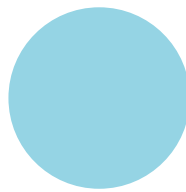

NCS S 0530-B10G

BAUX



ACOUSTIC TILES IN USE
SQUARE, RECTANGLE

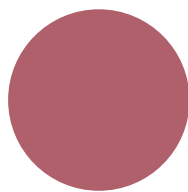

NCS 3040-R10B

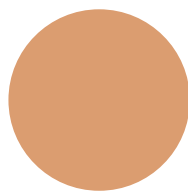

NCS S 2030-Y40R

BAUX



ACOUSTIC TILES IN USE
SQUARE, RECTANGLE

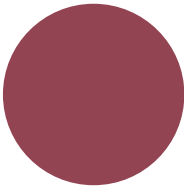

NCS S 4040-R10B

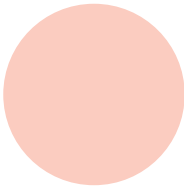

NCS S 0520-Y80R

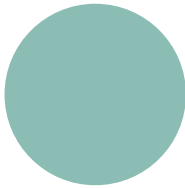

NCS S 2020-B70G

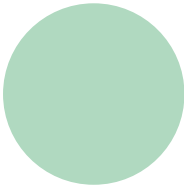

NCS S 1020-G

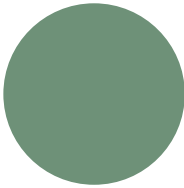

NCS S 4020-G10Y

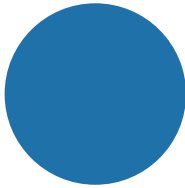

NCS S 3050-R90B

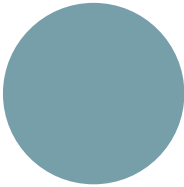

NCS S 3020-B10G

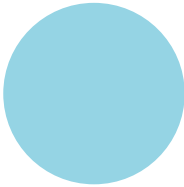

NCS S 0530-B10G

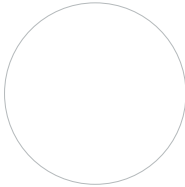

NCS S 0300-N

BAUX



ACOUSTIC TILES IN USE
SQUARE, RECTANGLE
PARALLELOGRAM, TRIANGLE

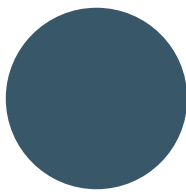

NCS S 6020-B

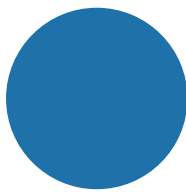

NCS S 3050-R90B

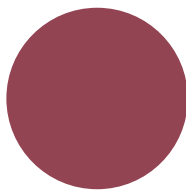

NCS S 4040-R10B

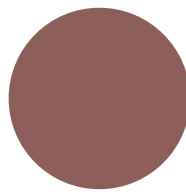

NCS S 5020-Y90R

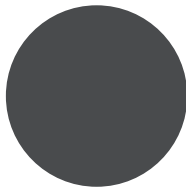

NCS S 7502-B

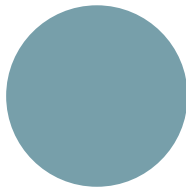

NCS S 3020-B10G

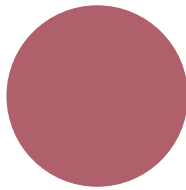

NCS 3040-R10B

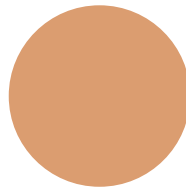

NCS S 2030-Y40R

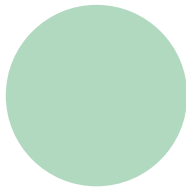

NCS S 1020-G

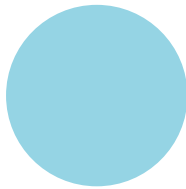

NCS S 0530-B10G

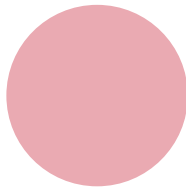

NCS S 1030-R10B

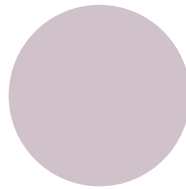

NCS S 1510-R40B

BAUX



ACOUSTIC TILES IN USE SQUARE

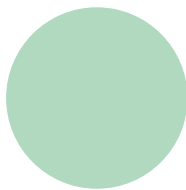

NCS S 1020-G

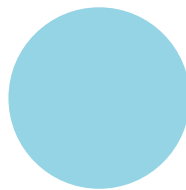

NCS S 0530-B10G

BAUX



ACOUSTIC TILES IN USE
SQUARE, RECTANGLE

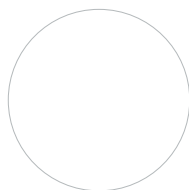

NCS S 0300-N

BAUX



ACOUSTIC TILES IN USE
SQUARE, RECTANGLE

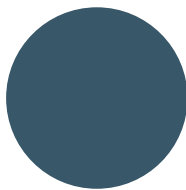

NCS S 6020-B

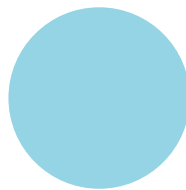

NCS S 0530-B10G

BAUX



ACOUSTIC TILES IN USE
SQUARE, RECTANGLE

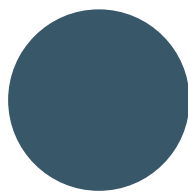

NCS S 6020-B

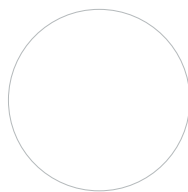

NCS S 0300-N

BAUX



ACOUSTIC TILES IN USE
SQUARE, RECTANGLE,
TRIANGLE

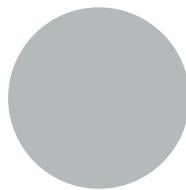

NCS S 2502-B

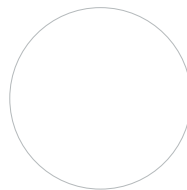

NCS S 0300-N

BAUX



ACOUSTIC TILES IN USE
SQUARE, RECTANGLE,
TRIANGLE

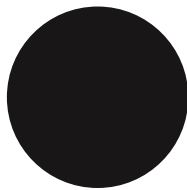

NCS 9000-N

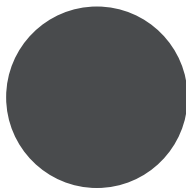

NCS S 7502-B

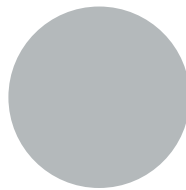

NCS S 2502-B

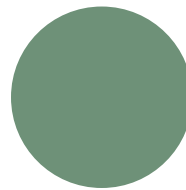

NCS S 4020-G10Y

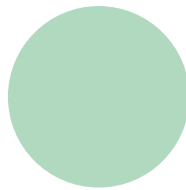

NCS S 1020-G

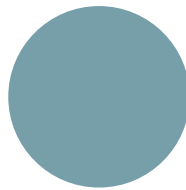

NCS S 3020-B10G

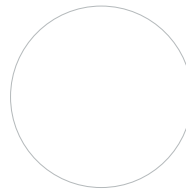

NCS S 0300-N

BAUX



ACOUSTIC TILES IN USE
SQUARE, RECTANGLE,
TRIANGLE

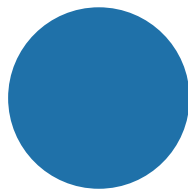

NCS S 3050-R90B

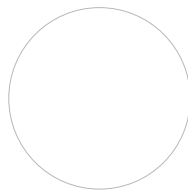

NCS S 0300-N

BAUX



ACOUSTIC TILES IN USE HEXAGON

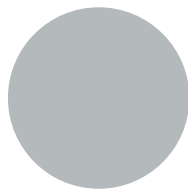

NCS S 2502-B

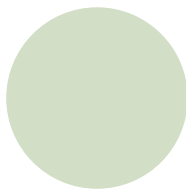

NCS S 1010-G30Y

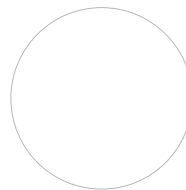

NCS S 0300-N

BAUX



ACOUSTIC TILES IN USE

CIRCLE

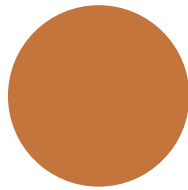

NCS 3050-Y40R

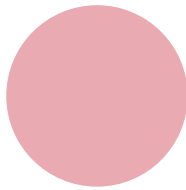

NCS S 1030-R10B

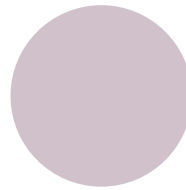

NCS S 1510-R40B

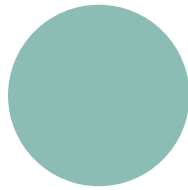

NCS S 2020-B70G

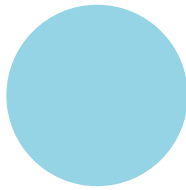

NCS S 0530-B10G

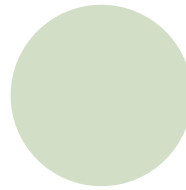

NCS S 1010-G30Y

BAUX



ACOUSTIC TILES IN USE
PLANK



NATURALLY COLOURED

BAUX



ACOUSTIC TILES IN USE
PLANK



NATURALLY COLOURED

BAUX



ACOUSTIC TILES IN USE
PLANK



NATURALLY COLOURED

BAUX



ACOUSTIC TILES IN USE
PLANK



NATURALLY COLOURED

BAUX



ACOUSTIC TILES IN USE
PLANK



NATURALLY COLOURED

BAUX

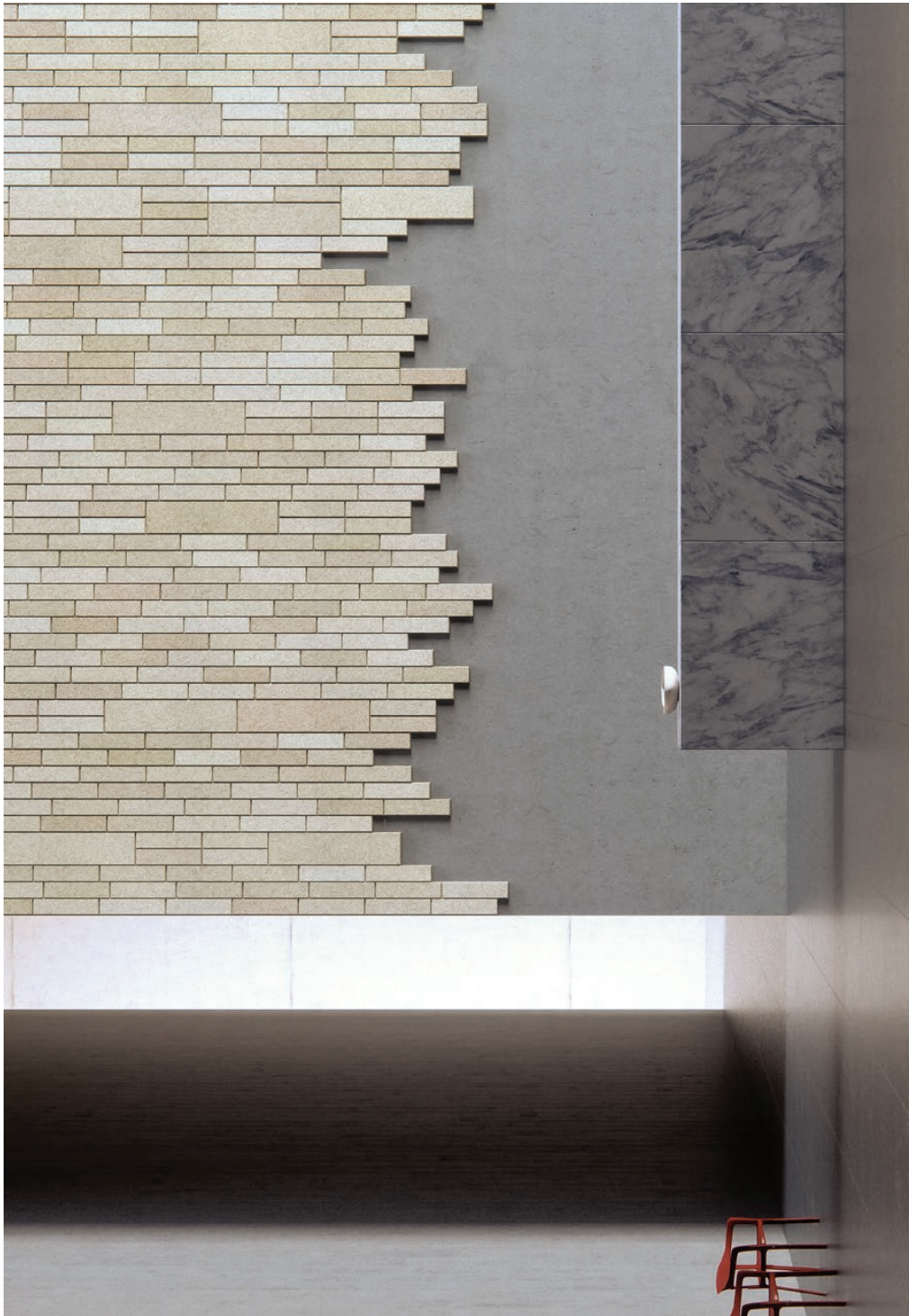

ACOUSTIC TILES IN USE
PLANK



NATURALLY COLOURED

BAUX

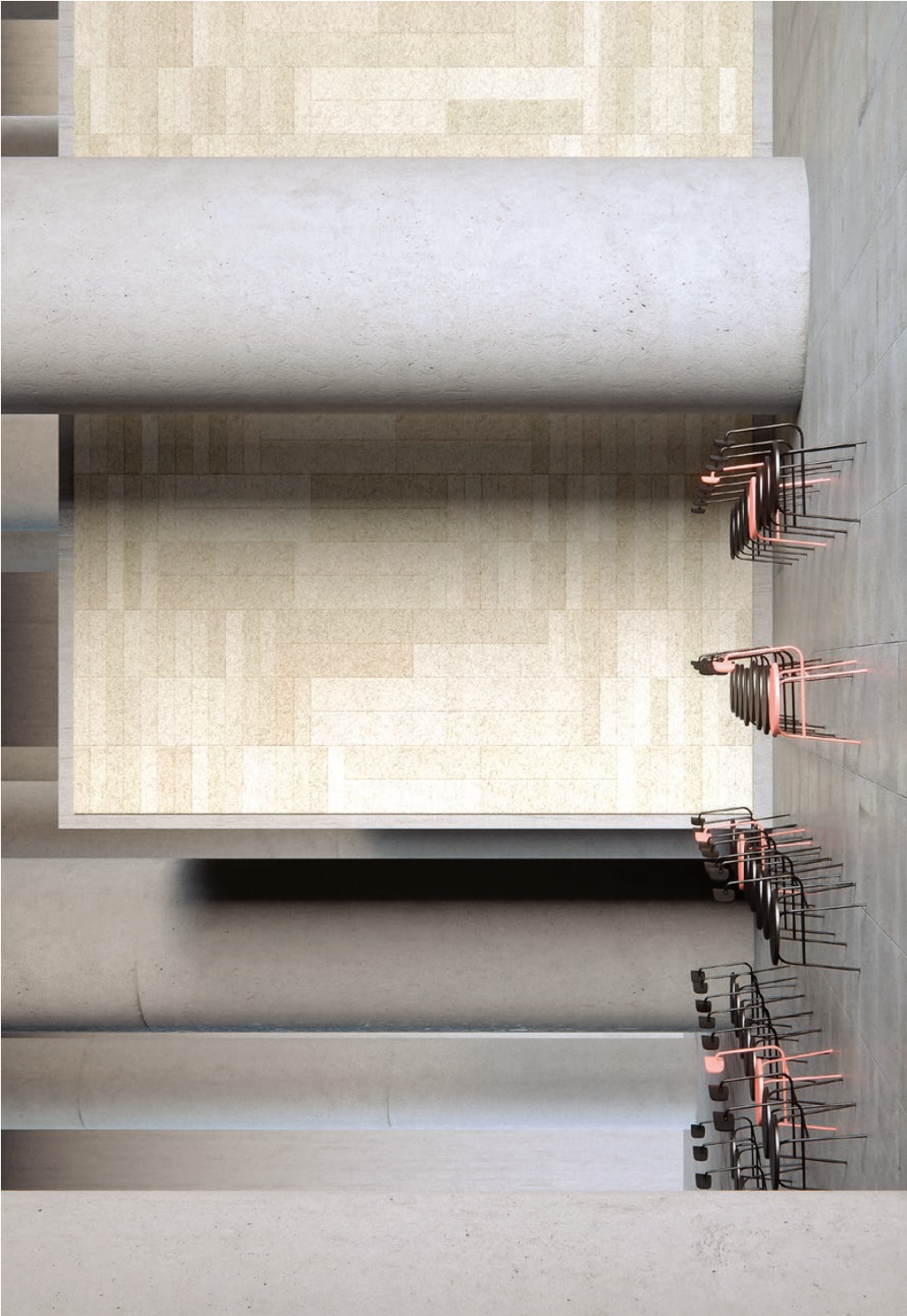

ACOUSTIC TILES IN USE
PLANK



NATURALLY COLOURED

BAUX



ACOUSTIC TILES IN USE
PLANK



NATURALLY COLOURED

BAUX

BAUX ACOUSTIC PANELS



ACOUSTIC PANELS QUILTED

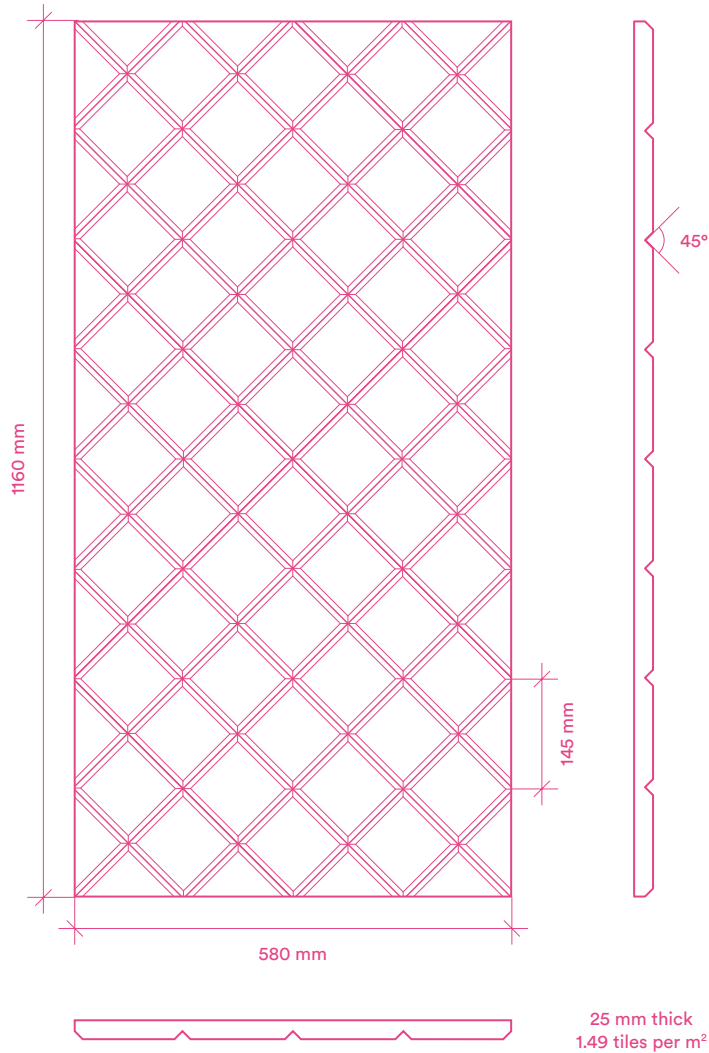

BAUX



ACOUSTIC PANELS STRIPES

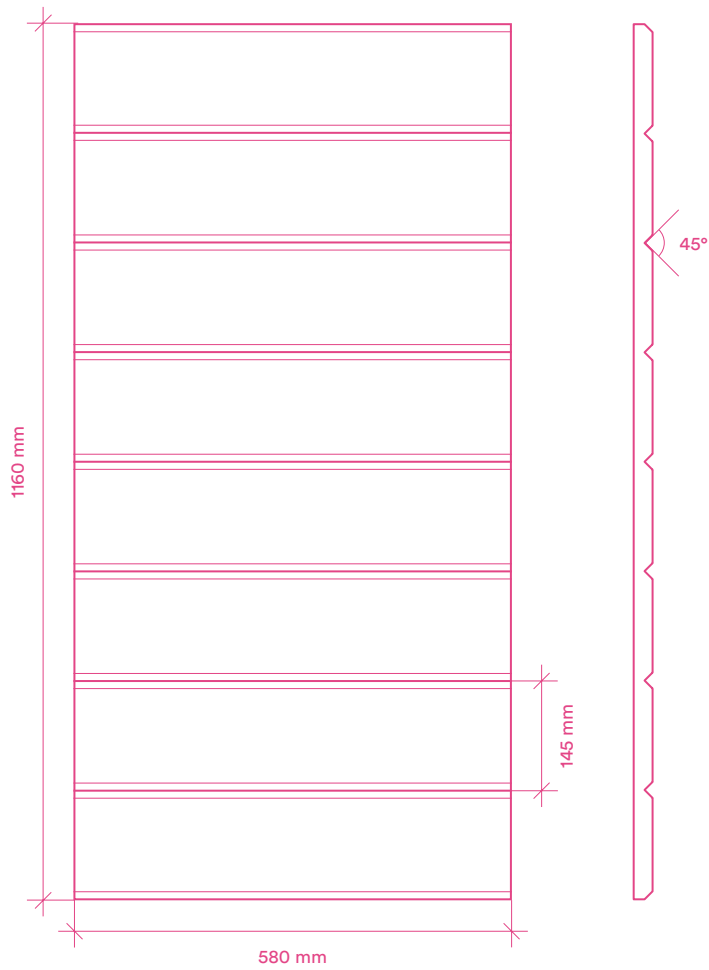

25 mm thick
1.49 tiles per m²

BAUX



ACOUSTIC PANELS DIAGONAL

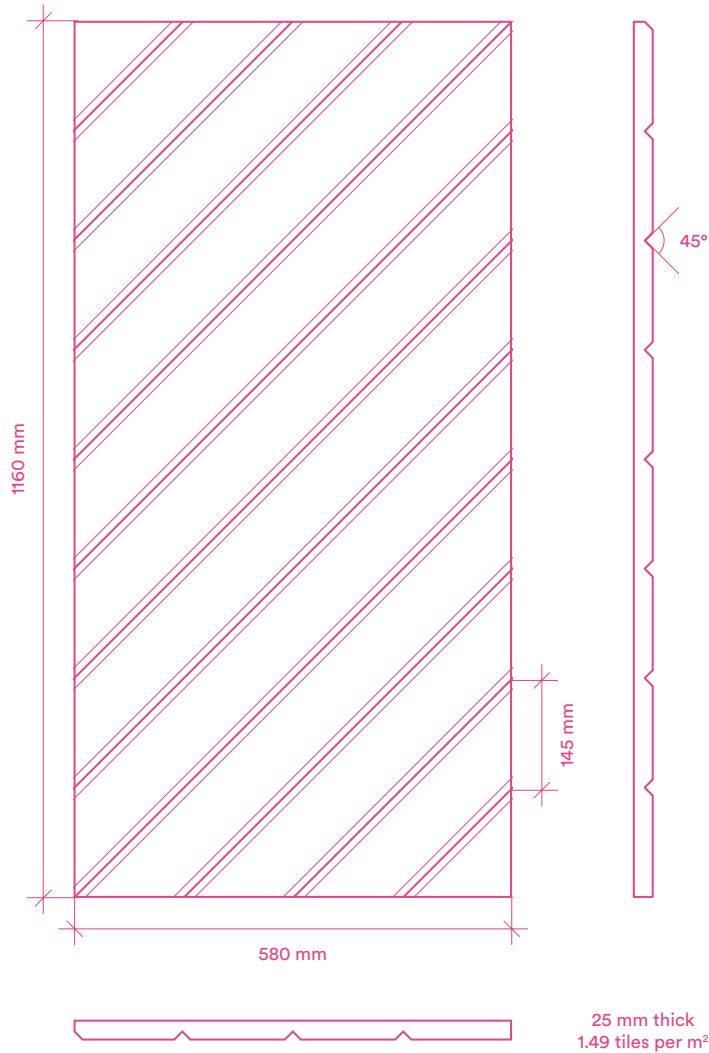

BAUX

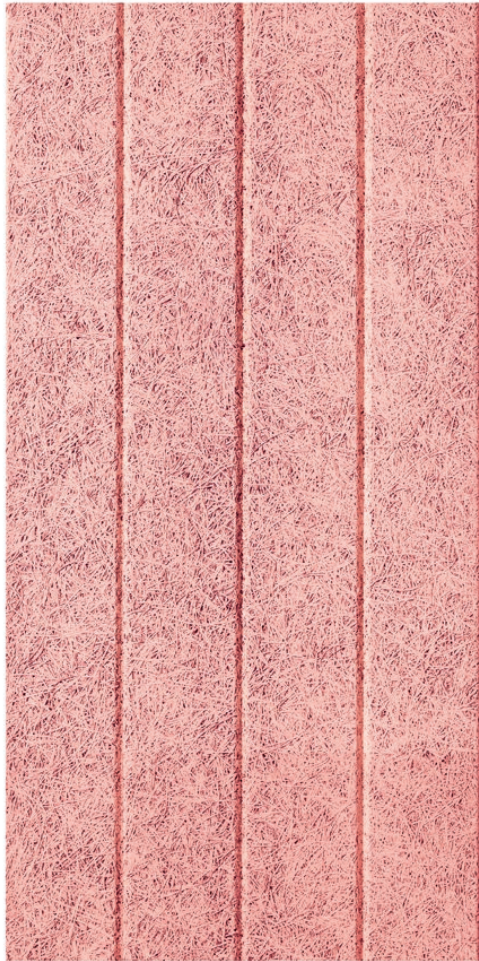

ACOUSTIC PANELS LINES

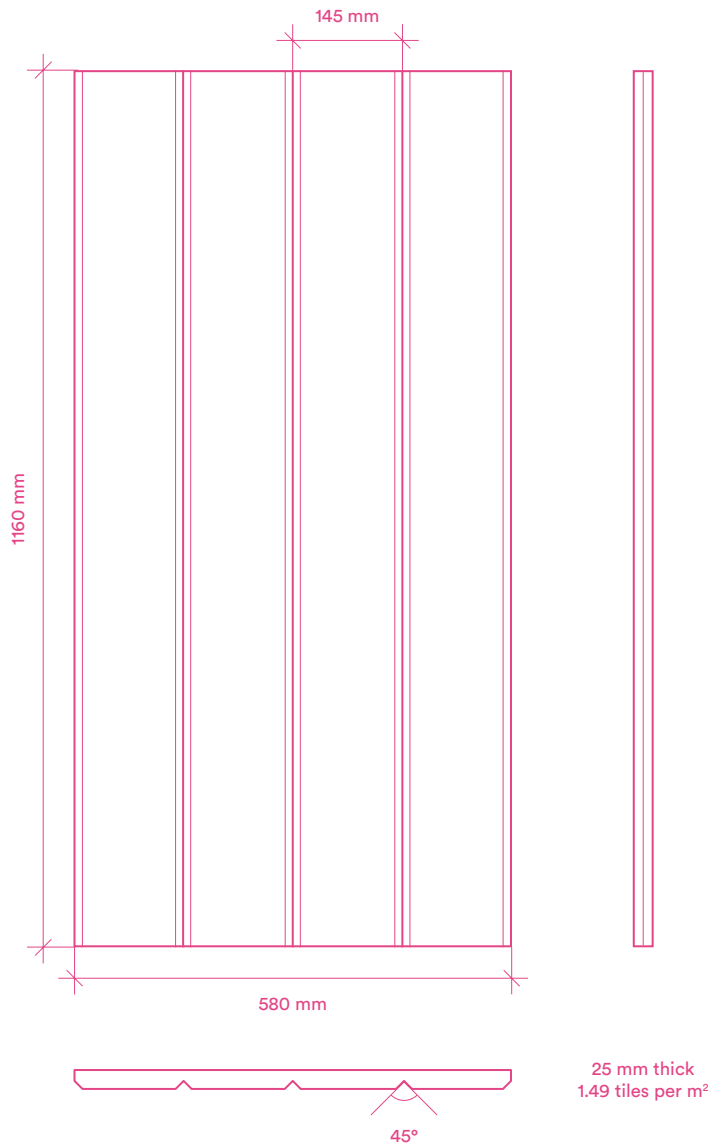

BAUX



ACOUSTIC PANELS CHECK

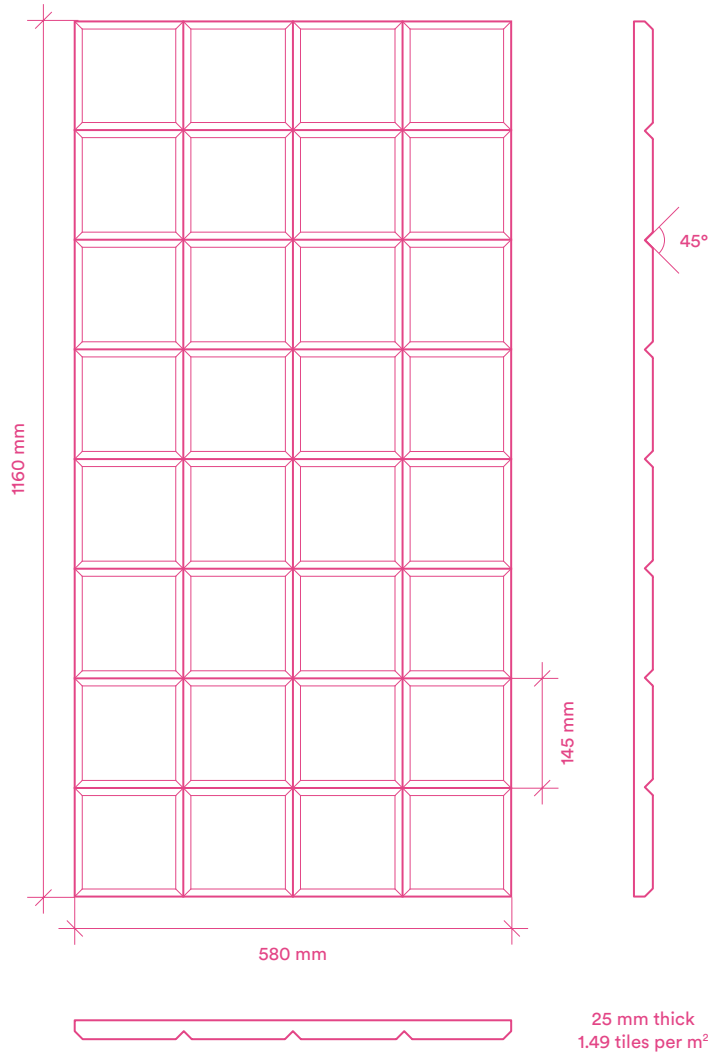

BAUX



ACOUSTIC PANELS ARCH

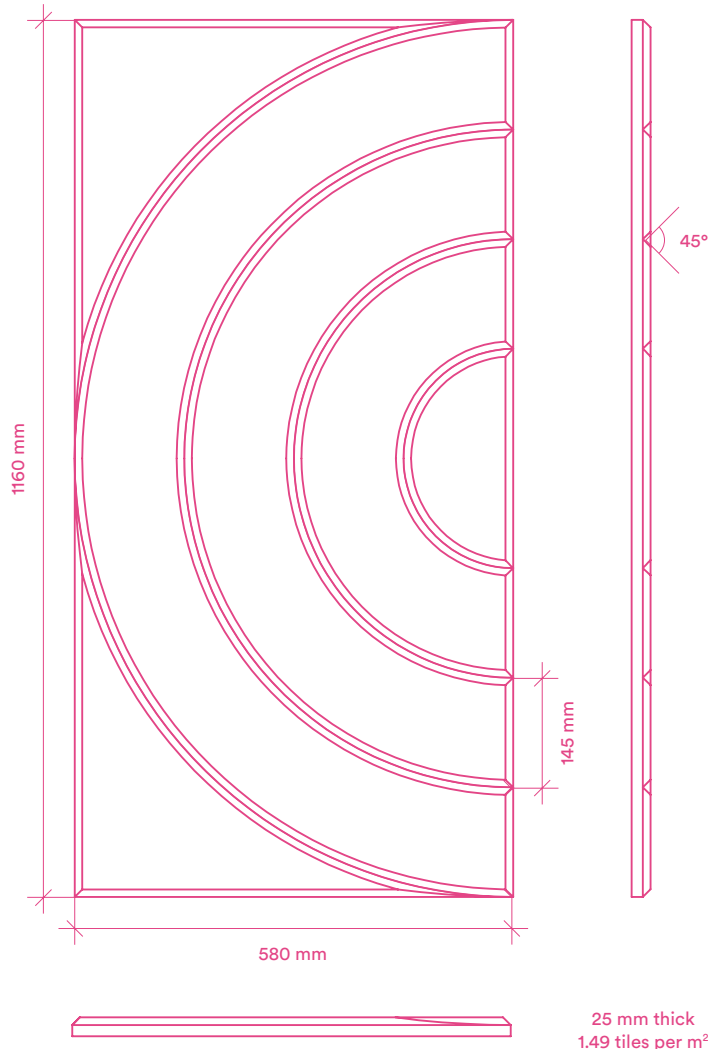

BAUX



ACOUSTIC PANELS CURVE

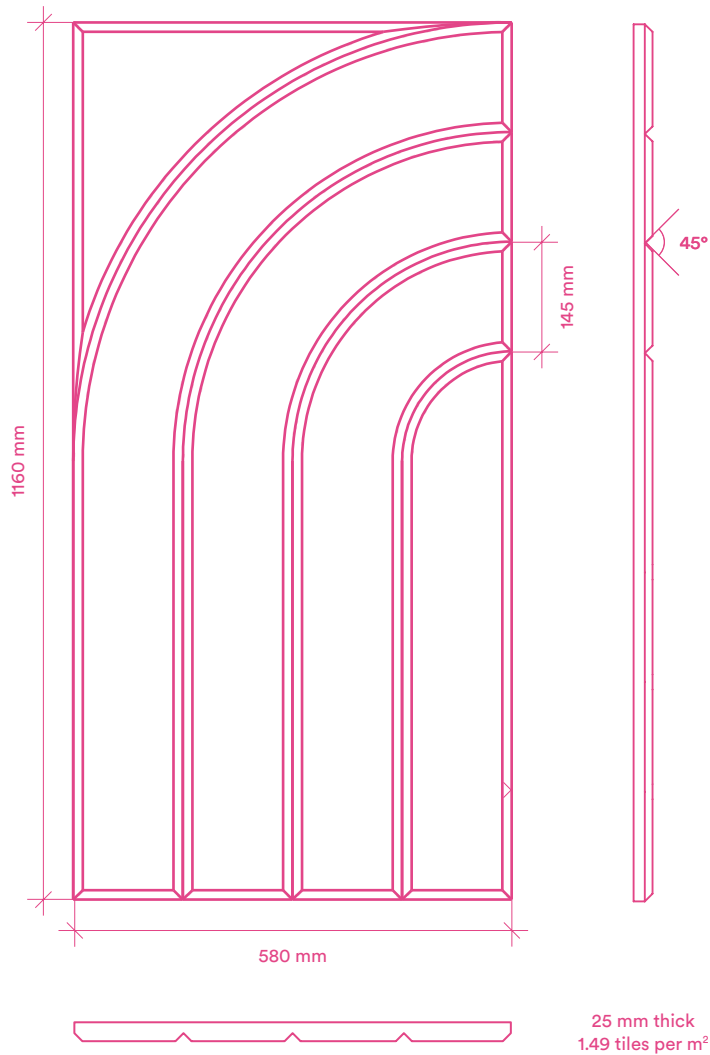

BAUX



ACOUSTIC PANELS IN USE DIAGONAL

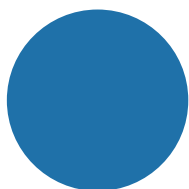

NCS S 3050-R90B

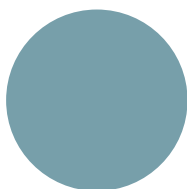

NCS S 3020-B10G

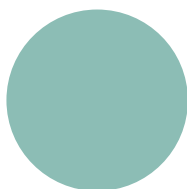

NCS S 2020-B70G

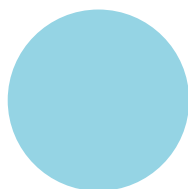

NCS S 0530-B10G

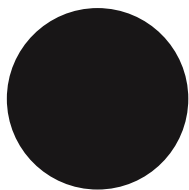

NCS 9000-N

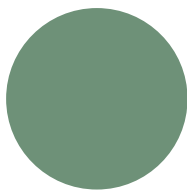

NCS S 4020-G10Y

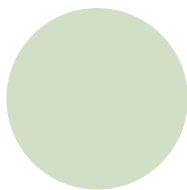

NCS S 1010-G30Y

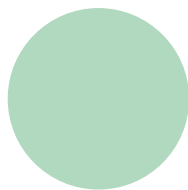

NCS S 1020-G

BAUX



ACOUSTIC PANELS IN USE
QUILTED, STRIPES, DIAGONAL,
LINES, CHECK

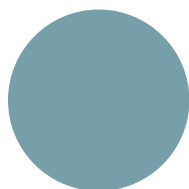

NCS S 3020-B10G

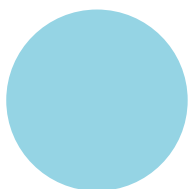

NCS S 0530-B10G

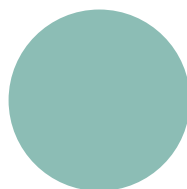

NCS S 2020-B70G

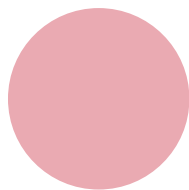

NCS S 1030-R10B

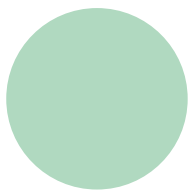

NCS S 1020-G

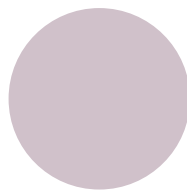

NCS S 1510-R40B

BAUX



ACOUSTIC PANELS IN USE DIAGONAL

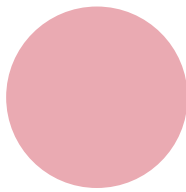

NCS S 1030-R10B

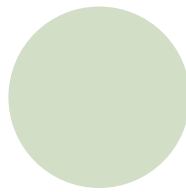

NCS S 1010-G30Y

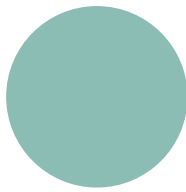

NCS S 2020-B70G

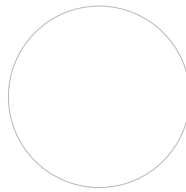

NCS S 0300-N

BAUX



ACOUSTIC PANELS IN USE QUILTED, STRIPES

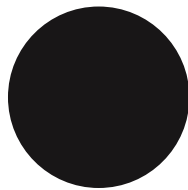

NCS 9000-N

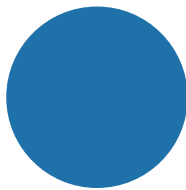

NCS S 3050-R90B

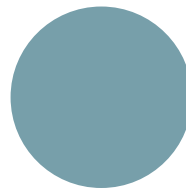

NCS S 3020-B10G

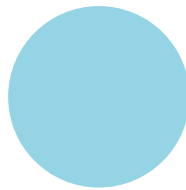

NCS S 0530-B10G

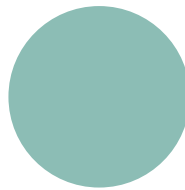

NCS S 2020-B70G

BAUX



ACOUSTIC PANELS IN USE DIAGONAL

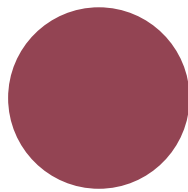

NCS S 4040-R10B

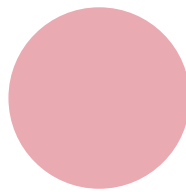

NCS S 1030-R10B

BAUX

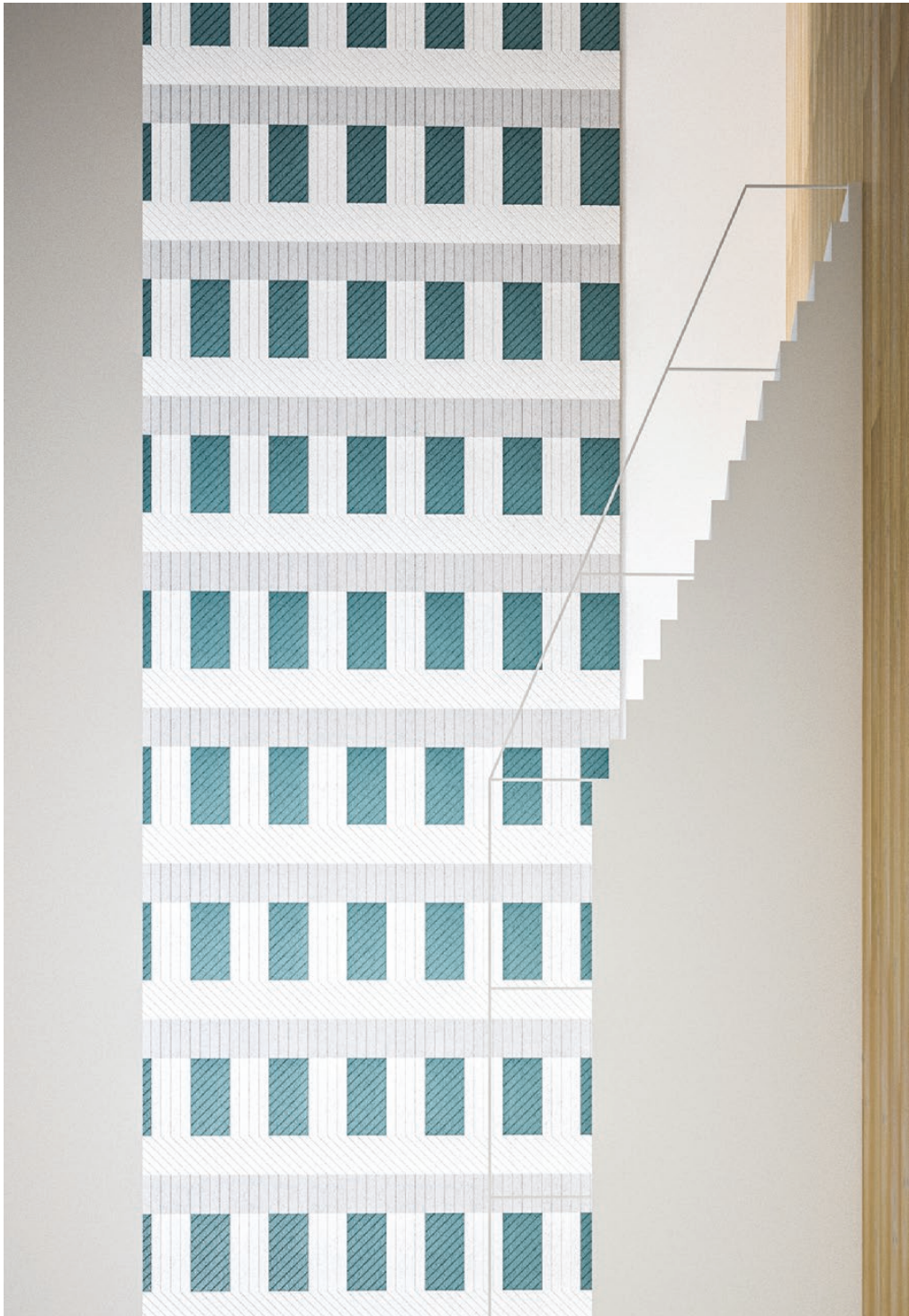

ACOUSTIC PANELS IN USE STRIPES, DIAGONAL, LINES

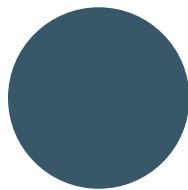

NCS S 6020-B

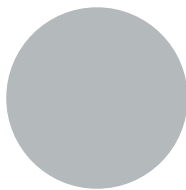

NCS S 2502-B

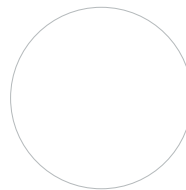

NCS S 0300-N

BAUX



ACOUSTIC PANELS IN USE LINES

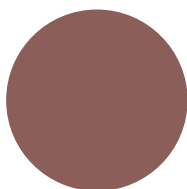

NCS S 5020-Y90R

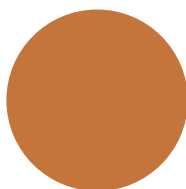

NCS 3050-Y40R

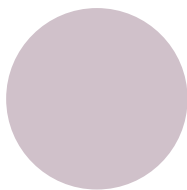

NCS S 1510-R40B

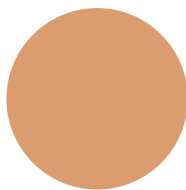

NCS S 2030-Y40R

BAUX



ACOUSTIC PANELS IN USE
QUILTED, STRIPES, DIAGONAL

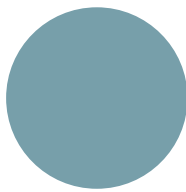

NCS S 3020-B10G

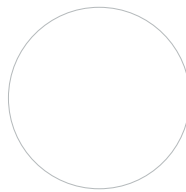

NCS S 0300-N

BAUX

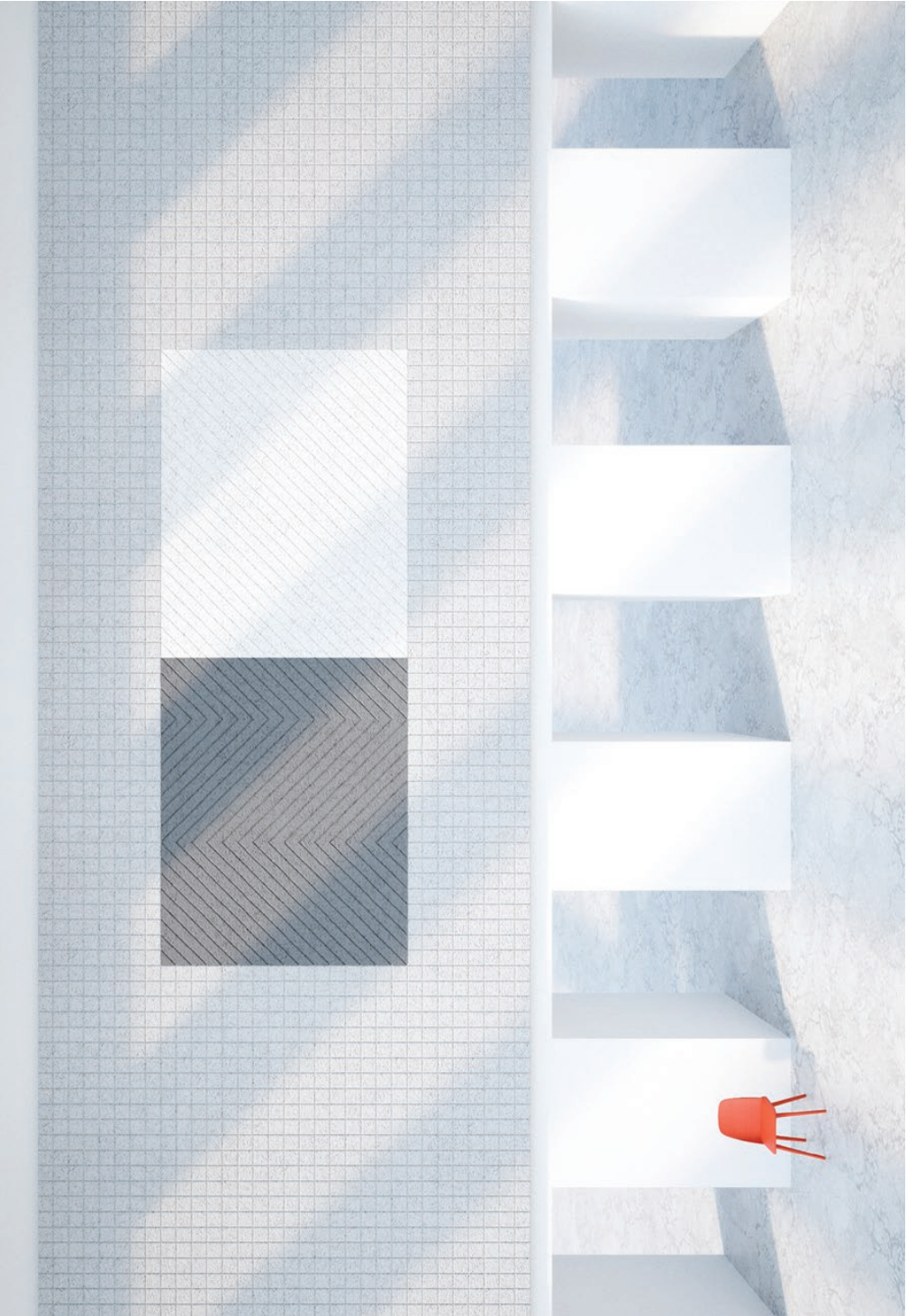

ACOUSTIC PANELS IN USE

DIAGONAL, CHECK

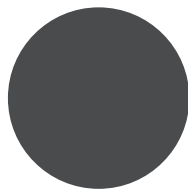

NCS S 7502-B

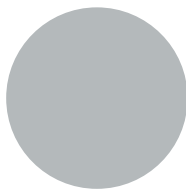

NCS S 2502-B

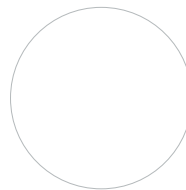

NCS S 0300-N

BAUX

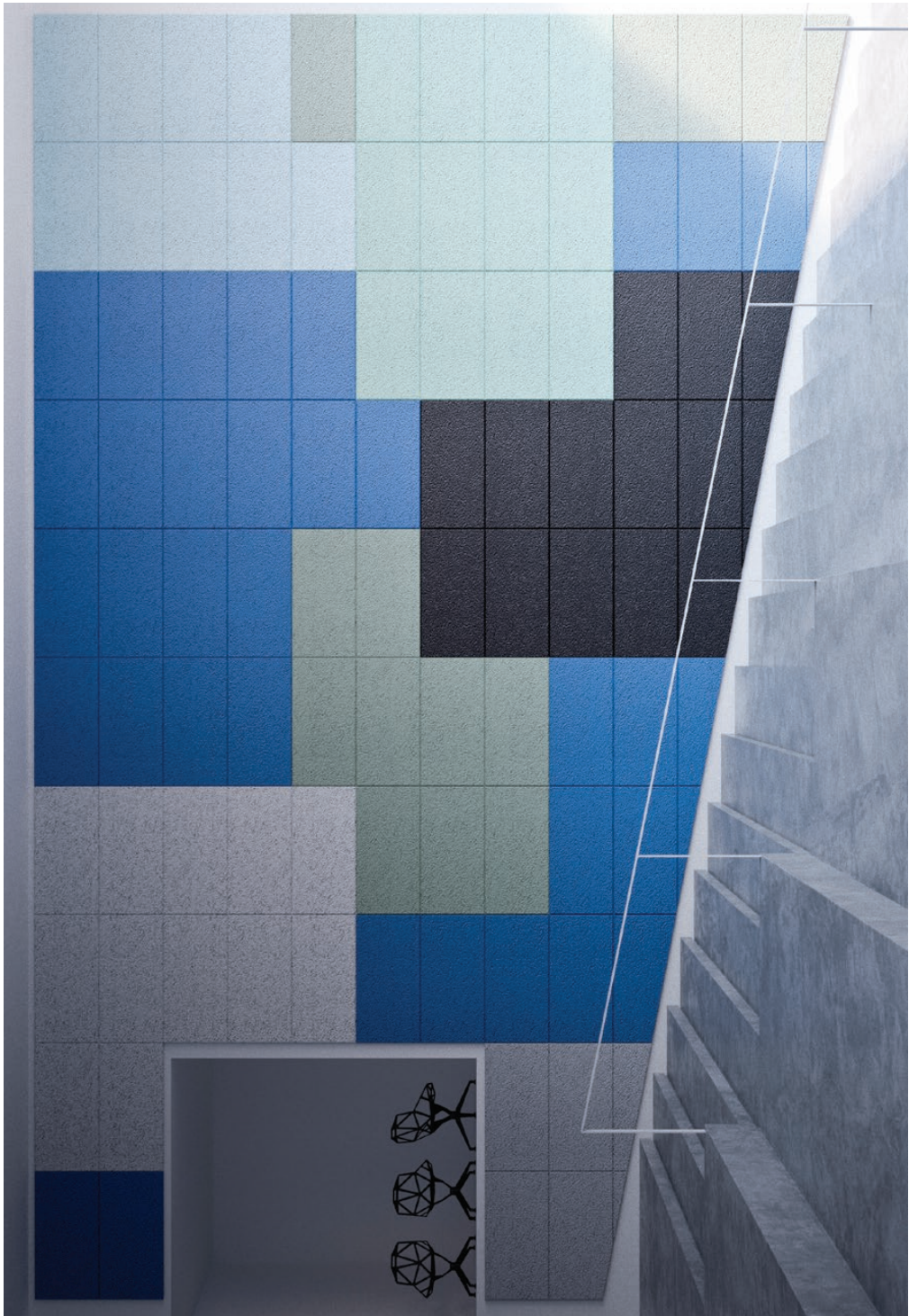

ACOUSTIC PANELS IN USE RECTANGLE

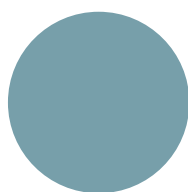

NCS S 3020-B10G

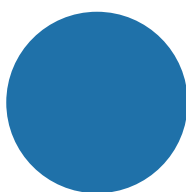

NCS S 3050-R90B

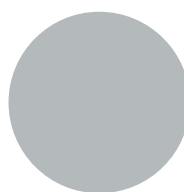

NCS S 2502-B

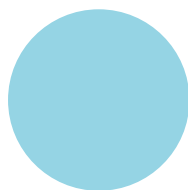

NCS S 0530-B10G

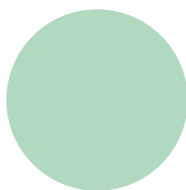

NCS S 1020-G



NCS S 1010-G30Y

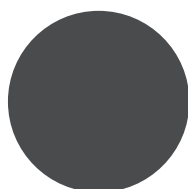

NCS S 7502-B

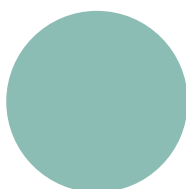

NCS S 2020-B70G

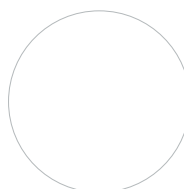

NCS S 0300-N

BAUX

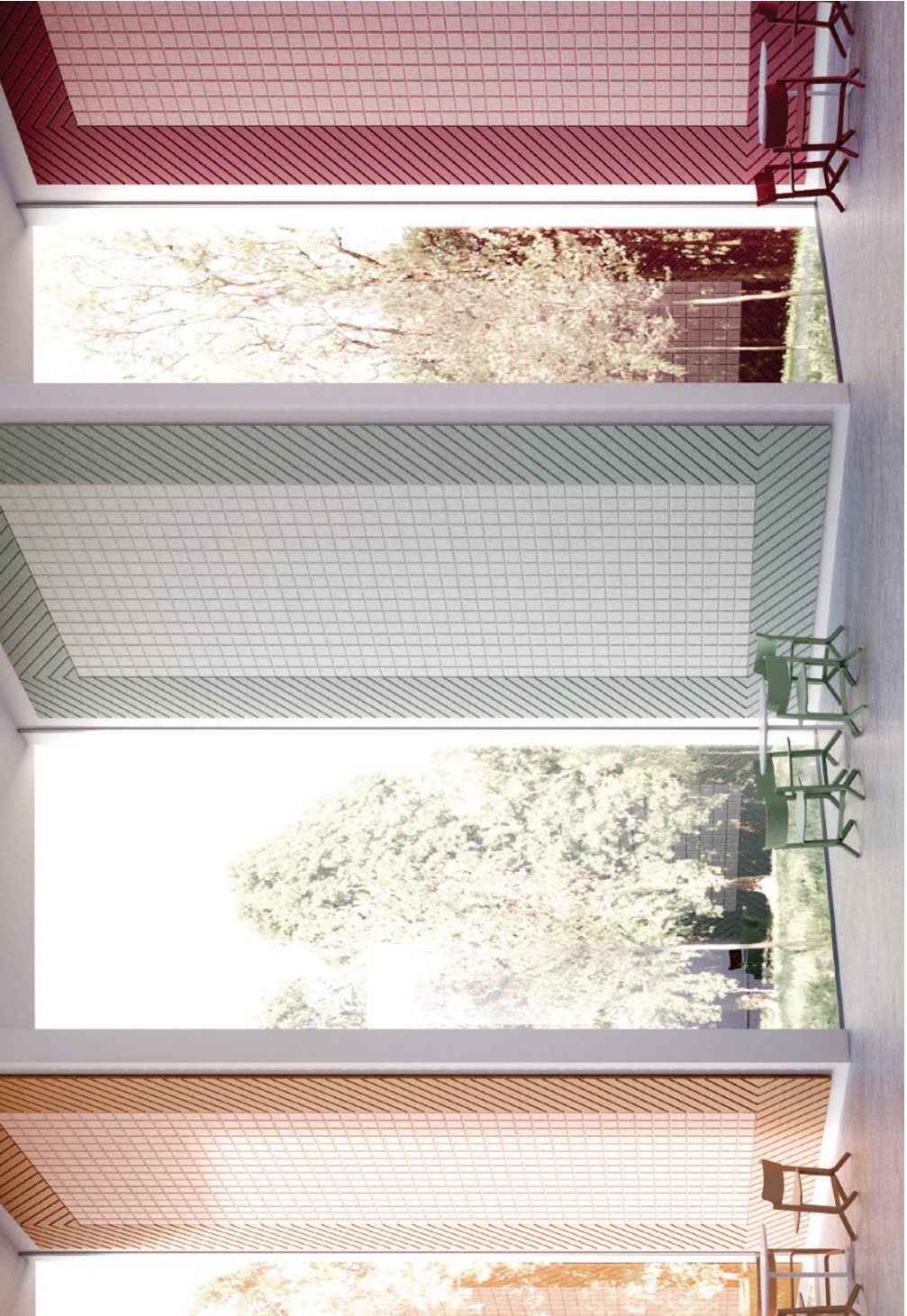

ACOUSTIC PANELS IN USE DIAGONAL, CHECK

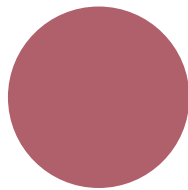

NCS 3040-R10B

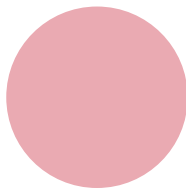

NCS S 1030-R10B

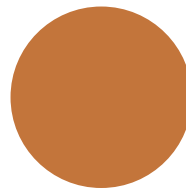

NCS 3050 -Y40R

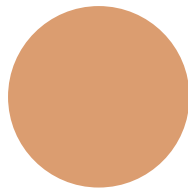

NCS S 2030-Y40R

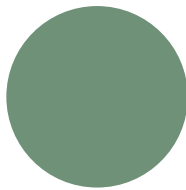

NCS S 4020-G10Y

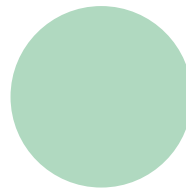

NCS S 1020-G

BAUX



ACOUSTIC PANELS IN USE DIAGONAL

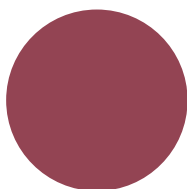

NCS S 4040-R10B

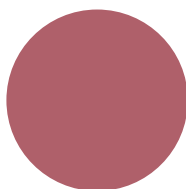

NCS 3040-R10B

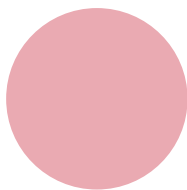

NCS S 1030-R10B

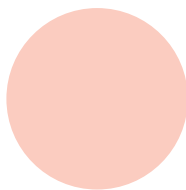

NCS S 0520-Y80R

BAUX



ACOUSTIC PANELS IN USE
QUILTED, STRIPES, DIAGONAL
LINES, CHECK

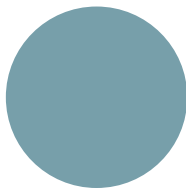

NCS S 3020-B10G

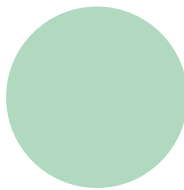

NCS S 1020-G

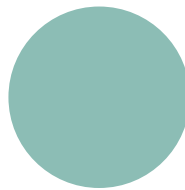

NCS S 2020-B70G

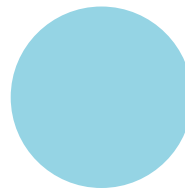

NCS S 0530-B10G

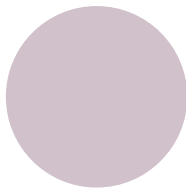

NCS S 1510-R40B

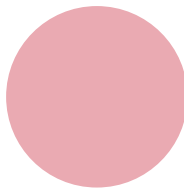

NCS S 1030-R10B

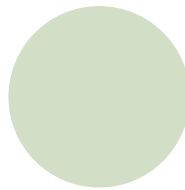

NCS S 1010-G30Y

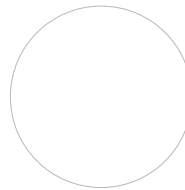

NCS S 0300-N

BAUX



ACOUSTIC PANELS IN USE

QUILTED, STRIPES

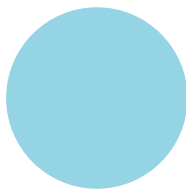

NCS S 0530-B10G

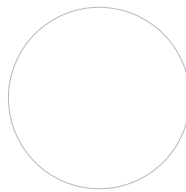

NCS S 0300-N

BAUX



ACOUSTIC PANELS IN USE
ARCH, CURVE, LINES

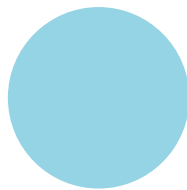

NCS S 0530-B10G

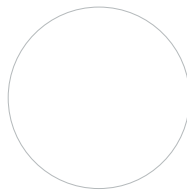

NCS S 0300-N

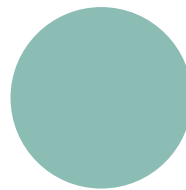

NCS S 2020-B70G

BAUX



ACOUSTIC PANELS IN USE
ARCH, CURVE

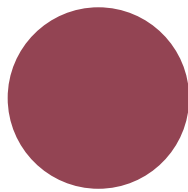

NCS S 4040-R10B

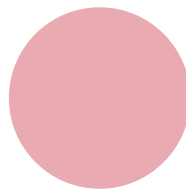

NCS S 1030-R10B

BAUX

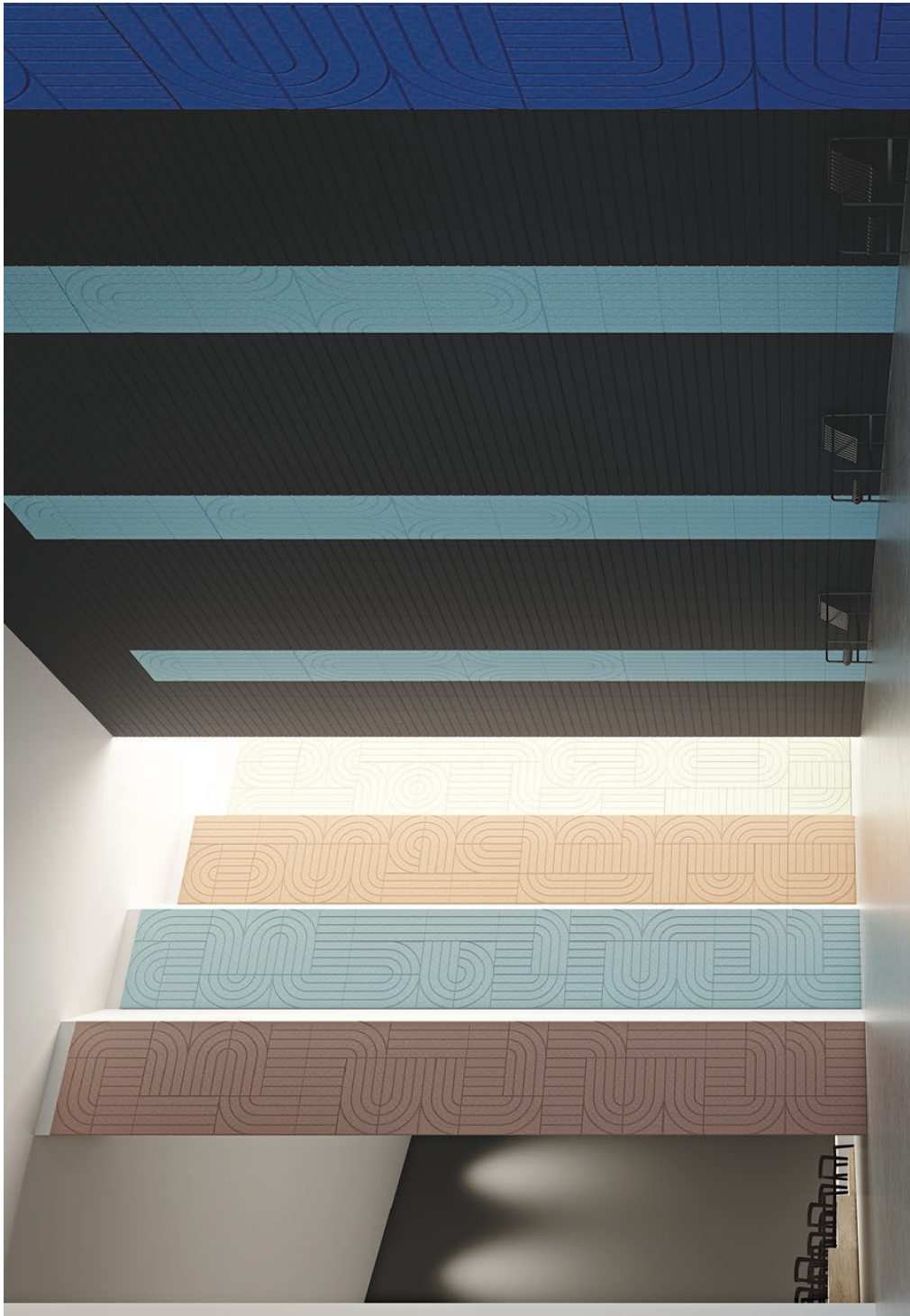

ACOUSTIC PANELS IN USE
ARCH, CURVE, LINES, STRIPES

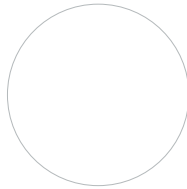

NCS S 0300-N

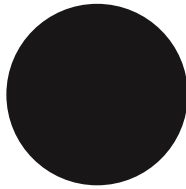

NCS 9000-N

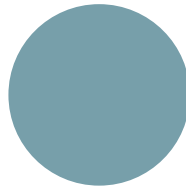

NCS S 3020-B10G

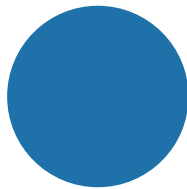

NCS S 3050-R90B

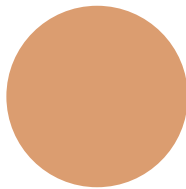

NCS S 2030-Y40R

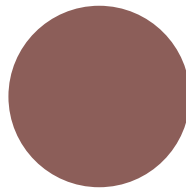

NCS S 5020-Y90R

BAUX

BAUX ACOUSTIC 3D

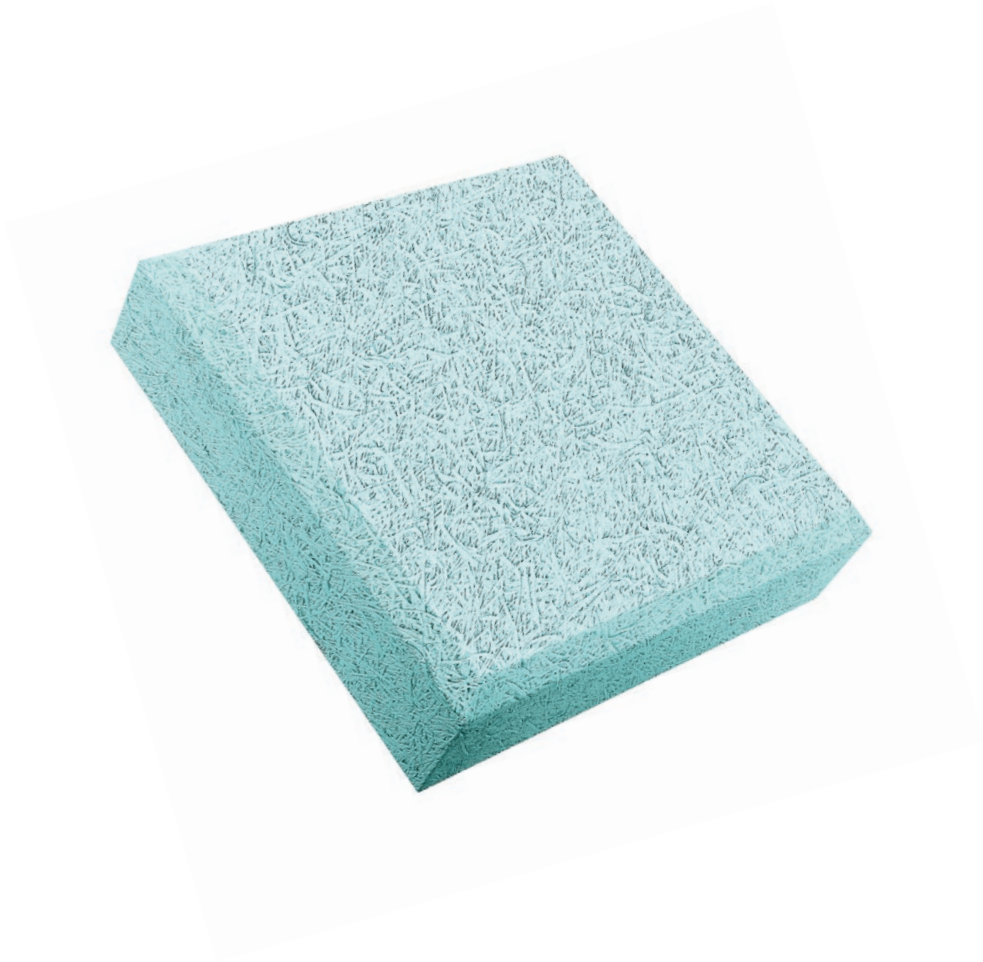

ACOUSTIC 3D

3D PIXEL

70

70 mm thick
11.9 tiles per m²

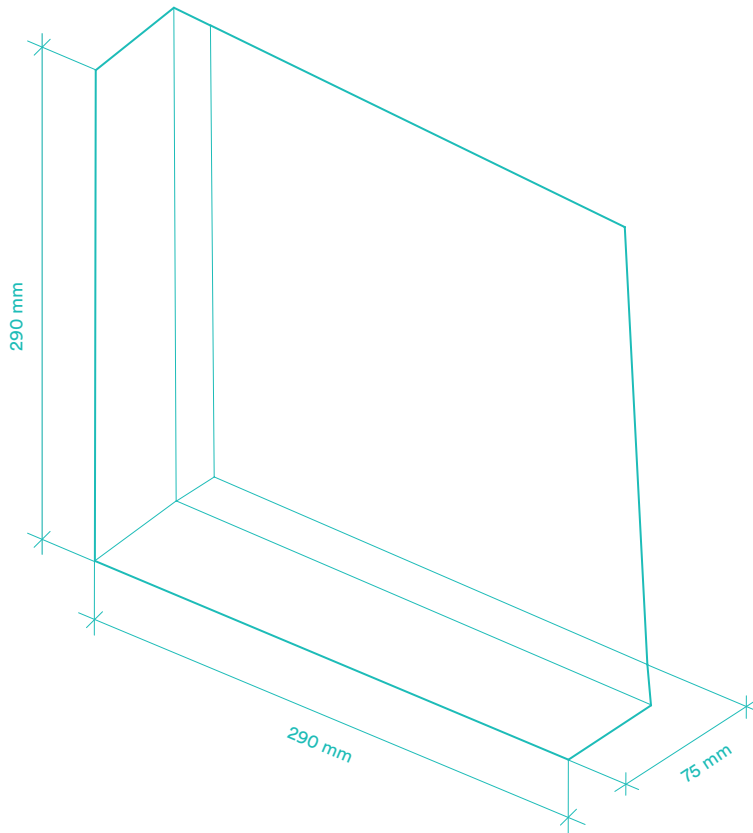

BAUX

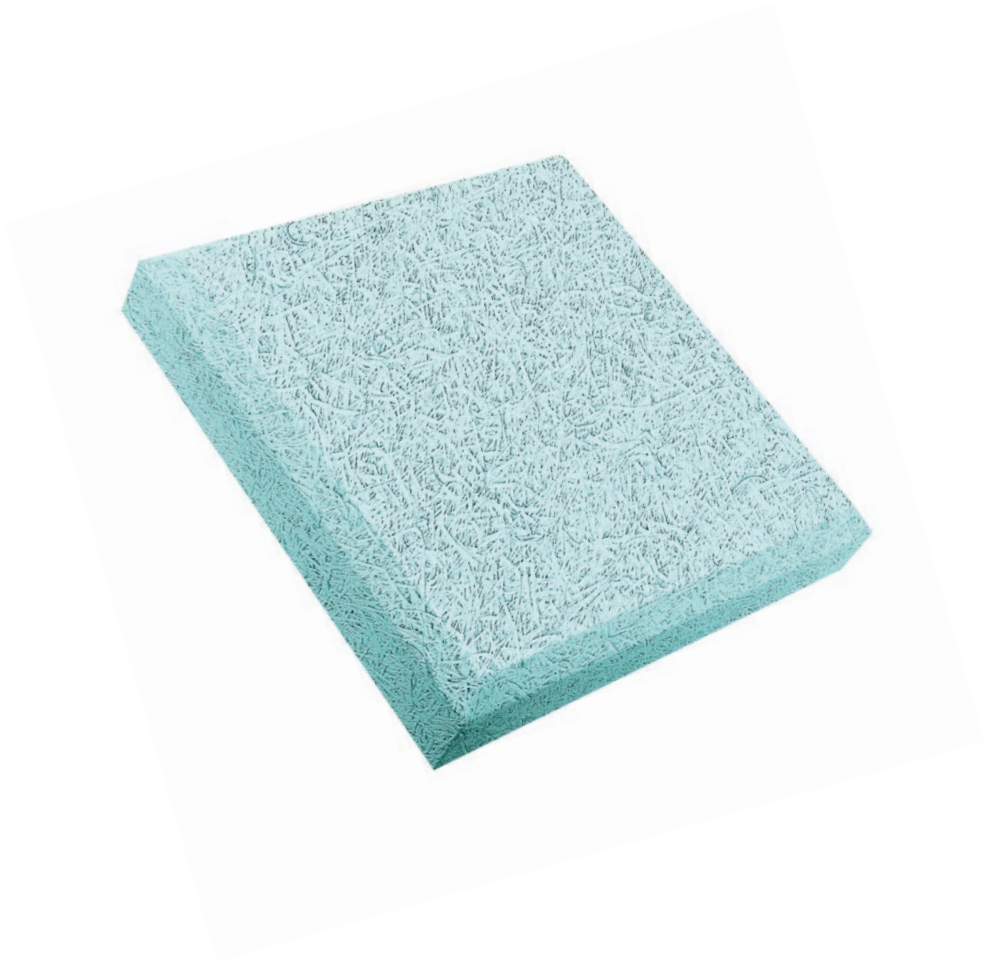

ACOUSTIC 3D

3D PIXEL

50

50 mm thick
11.9 tiles per m²

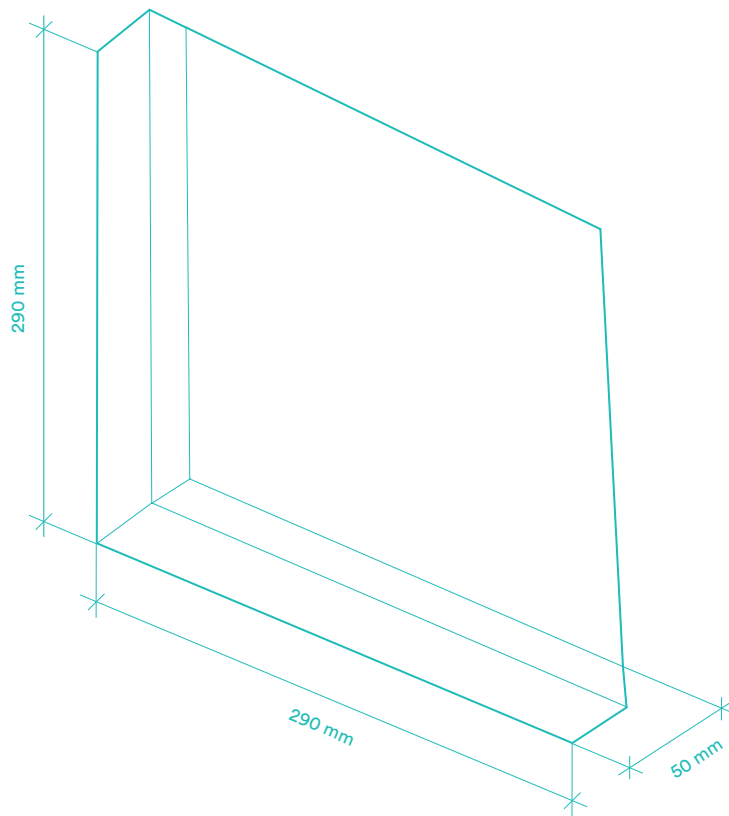

BAUX

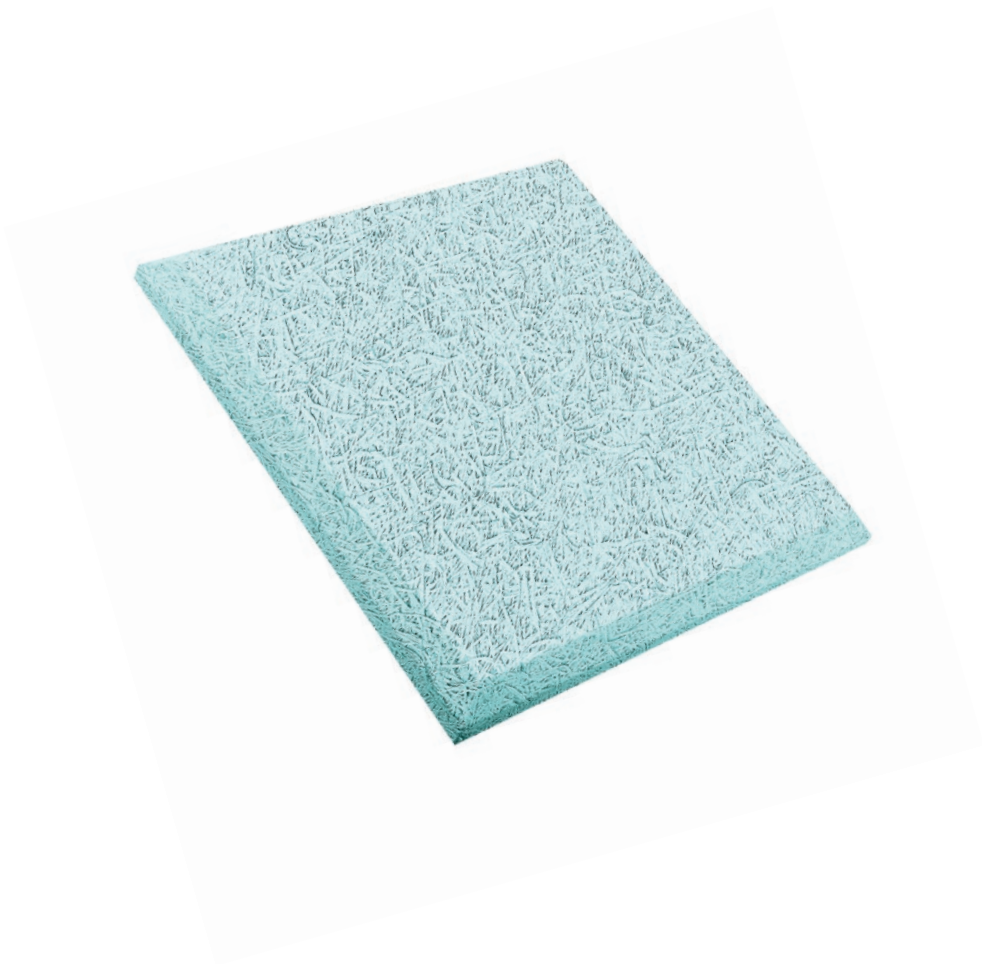

ACOUSTIC 3D
3D PIXEL
25

25 mm thick
11.9 tiles per m²

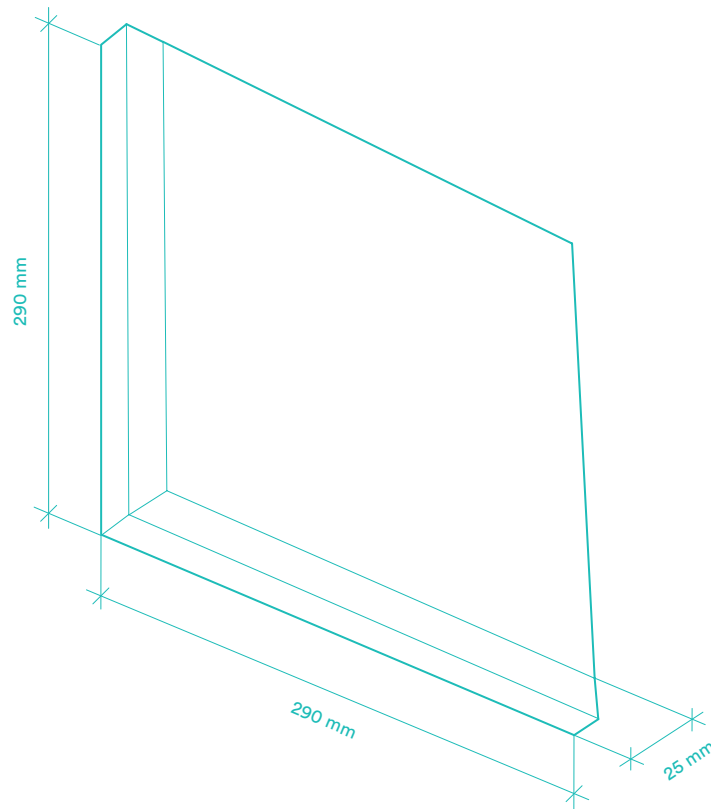

BAUX



3D PIXEL IN USE

25, 50, 75

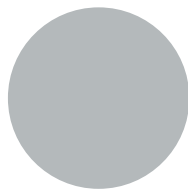

NCS S 2502-B

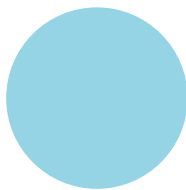

NCS S 0530-B10G

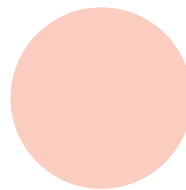

NCS S 2502-Y80R

BAUX



3D PIXEL IN USE

25, 50, 75

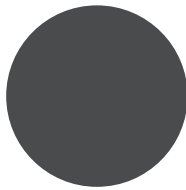

NCS S 7502-B

BAUX



3D PIXEL IN USE

25, 50, 75

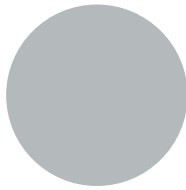

NCS S 2502-B

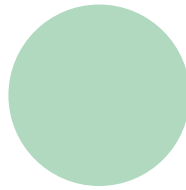

NCS S 1020-G

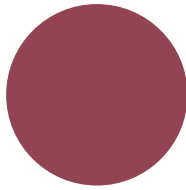

NCS S 4040-R10B

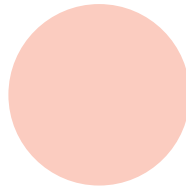

NCS S 0520-Y80R

BAUX



3D PIXEL IN USE

25, 50, 75

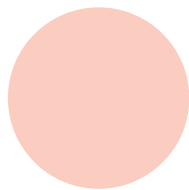

NCS S 0520-Y80R

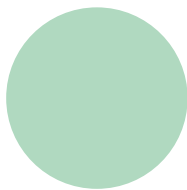

NCS S 1020-G

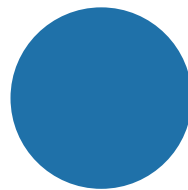

NCS S 3050-R90B

BAUX

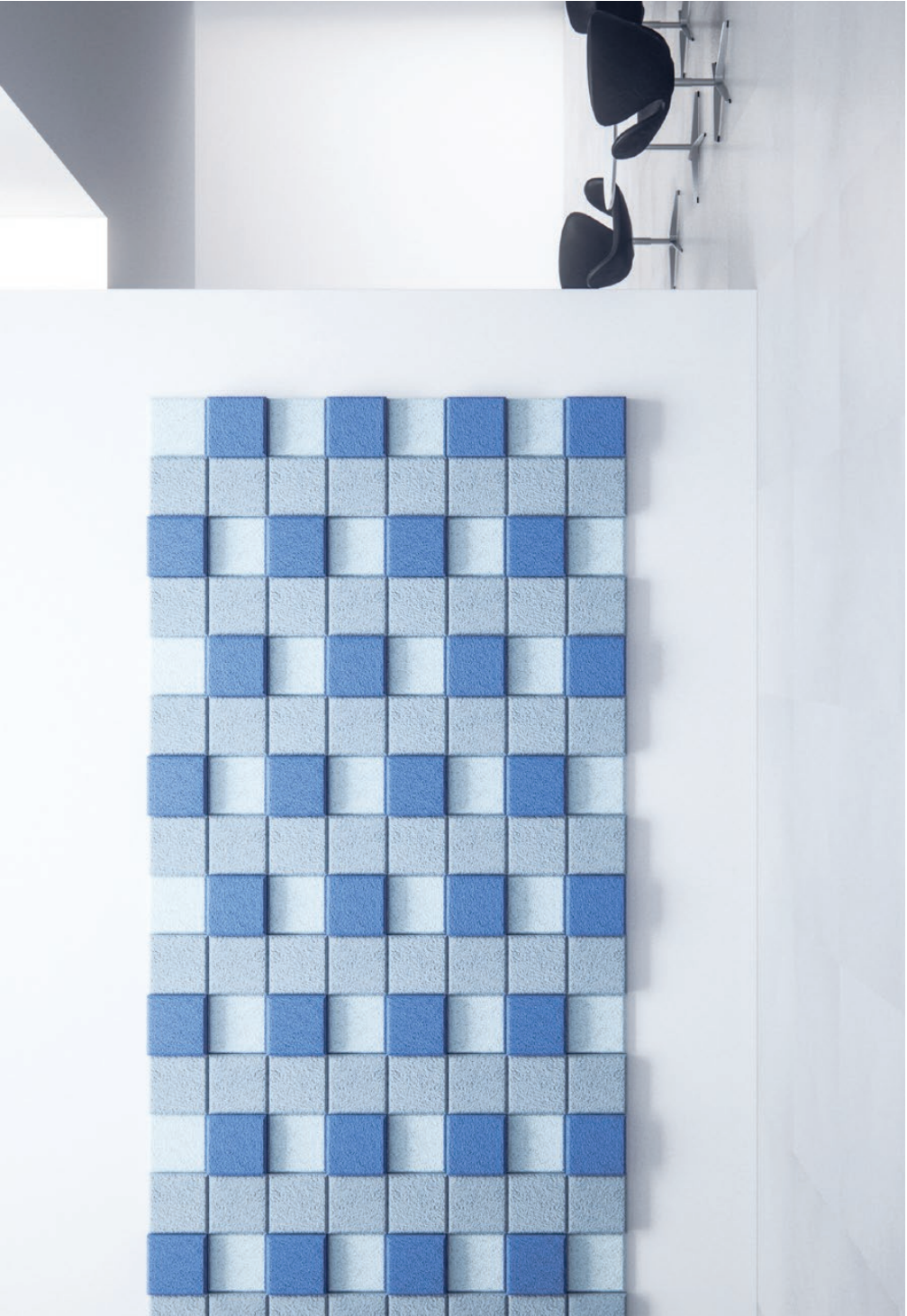

3D PIXEL IN USE

25, 50, 75

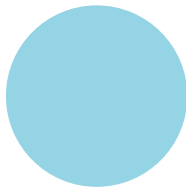

NCS S 0530-B10G

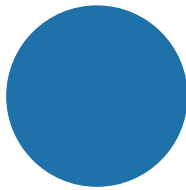

NCS S 3050-R90B

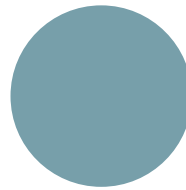

NCS S 3020-B10G

BAUX

COLOURS

CLOUDS

WOODS

SKY IN THE SEA

HEAT OF THE SUN

EARTH AND MOUNTAIN

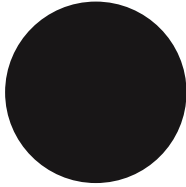

NCS 9000-N

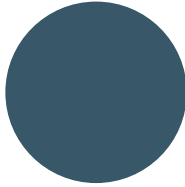

NCS S 6020-B

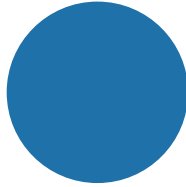

NCS S 3050-R90B

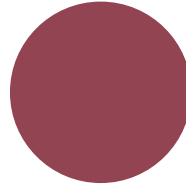

NCS S 4040-R10B

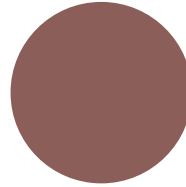

NCS S 5020-Y90R

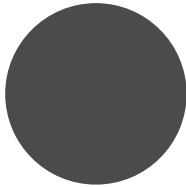

NCS S 7502-B

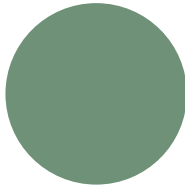

NCS S 4020-G10Y

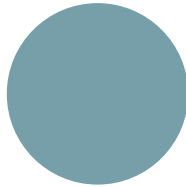

NCS S 3020-B10G

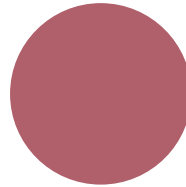

NCS 3040-R10B

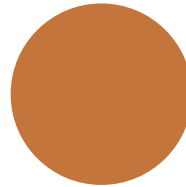

NCS 3050-Y40R

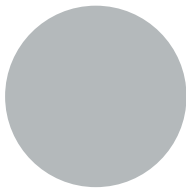

NCS S 2502-B

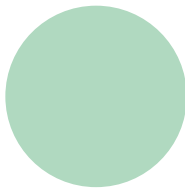

NCS S 1020-G

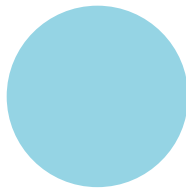

NCS S 0530-B10G

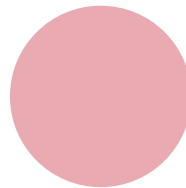

NCS S 1030-R10B

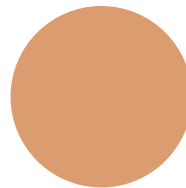

NCS S 2030-Y40R

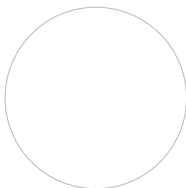

NCS S 0300-N

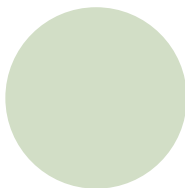

NCS S 1010-G30Y

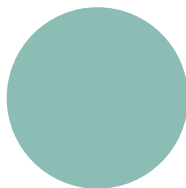

NCS S 2020-B70G

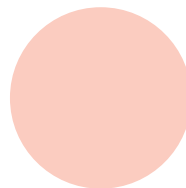

NCS S 0520-Y80R

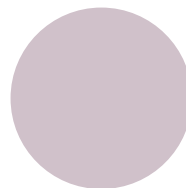

NCS S 1510-R40B

COLOUR SCHEMES

CLOUDS ●●●○

Light colours are expansive and airy, making rooms seem larger and brighter. Dark colours are sophisticated and warm.

WOODS ●●●●

Green is considered the most restful colour for the eye.

SKY IN THE SEA ●●●●

Blue, calming and relaxing. Lowers blood pressure.

HEAT OF THE SUN ●●●●

Stir up the excitement. Red has been shown to raise blood pressure.

EARTH AND MOUNTAIN ●●●●

Orange evokes excitement, enthusiasm and is an energetic colour.

BAUX

BAUX FACTS

BAUX ACOUSTIC WOOD WOOL PRODUCTS

Wood wool is a functional, natural material.

BAUX Acoustic Wood Wool is made from two of the world's oldest building materials, wood and cement.

The combination is simple and ingenious. Wood fibre offers excellent insulation, heat retention and sound absorption. Cement, a proven and popular building material, is the binder that provides strength, moisture resistance and fire protection. Therefore, BAUX Acoustic products are versatile and durable in all climates.

MAIN CHARACTERISTICS

- Sound absorption
- Thermal insulation
- Fire resistant
- Wet and dry rot resistant
- Freeze-thaw resistant
- Termite and vermin resistant

BAUX Acoustic products meet contemporary expectations of architects and designers with a canny combination of form and function. They can be combined to create remarkable structural patterns that rejuvenate residential, industrial and public spaces.

Designed by the renowned Swedish design studio, Form Us With Love, BAUX Acoustic Tiles and Panels are available in five colour sets and a range of beautiful patterns. Designers and architects can personalize any installation with endless creative possibilities.

SOUND

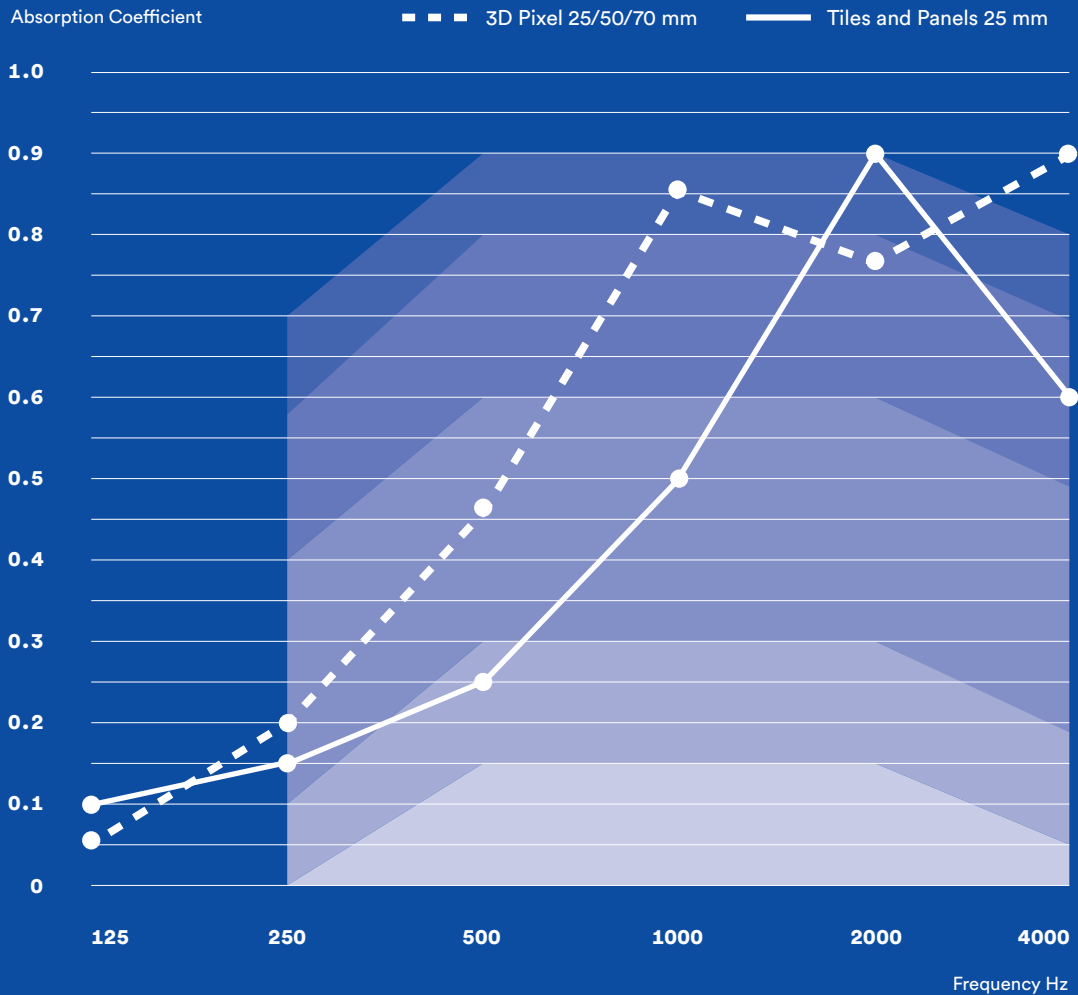

This graph shows the practical absorption coefficient of 25 mm thick BAUX Acoustic Wood Wool at any given audio frequency.

The material structure of BAUX Acoustic products reduces sound reflections, making it a great sound absorber. The material dampens noise and contributes to restful acoustics in residential buildings, industrial premises and public spaces.

FIREPROOF

BAUX Acoustic Wood Wool products are type approved as protective cladding with a class 1 coating.

HEAT AND MOISTURE

BAUX Acoustic Wood Wool products store ambient heat and release it when the air temperature falls. This contributes to lower energy costs, reduced environmental impact and stable indoor climates.

BAUX Acoustic products are rot resistant. Also, they even out humidity by absorbing and emitting moisture into the air, creating a pleasant indoor climate, good for both health and comfort. A high pH value discourages mould growth.

ENVIRONMENT

The BAUX Acoustic products are made of an environmentally friendly building material containing three natural ingredients; spruce tree wool, clean water and cement.

EMISSION MEASUREMENTS

The Swedish Institute of Technical Research tested BAUX Acoustic Wood Wool products for emissions and reported the results in protocol 90K 10102. Their results show emissions of less than $11 \mu\text{g}/\text{m}^2 \times \text{h}$.

DUST

RNK in Borås and Sitac, have measured the particle attrition for 10-year-old wood wool boards at Tingsholmsgymnasiet in Ulricehamn (10/05/1995). The ceiling surface was “dust provoked” by a powerful jet of air. No measurable particle attrition was noted.

ENVIRONMENTAL PRODUCT DECLARATION

The Environmental Product Declaration, drawn up in accordance with the instructions from Byggsektorns Kretsloppsråd (the Construction Sector Ecocycle), may be ordered at www.byggjtjanst.se

ENVIRONMENT



The wood is collected close to the factory in Österbymo, Småland, Sweden. Thanks to this we can minimize the environmental effect.

MOUNTING AND HANDLING

BAUX Acoustic Tiles, Panels and Pixel 3D can be attached with glue or magnets, which are fastened to the back of each panel. Thin metal sheets can then be attached to the underlying surface (wall or ceiling) and the panels can be arranged according to your design. The magnets have a life expectancy of more than one hundred years.

Contact us for advice on the most suitable option for your project.

ABOUT BAUX

We founded BAUX on the belief that building materials should be surprisingly functional and remarkably beautiful. We're here to inject some X into BAU! BAUX designs, produces and markets functional construction materials that meet the contemporary expectations of architects, engineers and builders — without compromising tomorrow's safety and environmental standards.

BAUX is a joint venture between entrepreneurs: Johan Ronnestam, Fredrik Franzon and the founding partners of design studio Form Us With Love: Jonas Pettersson, John Löfgren and Petrus Palmér.



johan@baux.se



fredrik@baux.se



jonas@baux.se



john@baux.se



petrus@baux.se

GET IN TOUCH

INFO@BAUX.SE
WWW.BAUX.SE

BAUX